

Schedule

Land	The unexpired term of the Lease	Unit	UP No.	Block	Section	Division/District
				1	46	Fraser
		and known as 34 Carrodus Street, Fraser				
Seller	Full name	Allison Louise Johnston and John William Dessent				
	ACN/ABN					
	Address	34 Carrodus Street, Fraser ACT 2615				
Seller Solicitor	Firm	Bedfords Legal				
	Email	helen@bedfordslegal.com.au				
	Phone	(02) 6285 2900	Ref: Helen Rodríguez			
	DX/Address	PO Box 780, Woden ACT 2606				
Stakeholder	Name	Dominium Real Estate Sales Trust Account				
Seller Agent	Firm	Dominium Real Estate				
	Email	nathan@dominiumre.au				
	Phone	0497 145 482	Ref: Nathan Giannasca			
	DX/Address					
Restriction on Transfer	Mark as applicable	<input checked="" type="checkbox"/> Nil	<input type="checkbox"/> section 370	<input type="checkbox"/> section 280	<input type="checkbox"/> section 306	<input type="checkbox"/> section 351
Land Rent	Mark one	<input checked="" type="checkbox"/> Non-Land Rent Lease	<input type="checkbox"/> Land Rent Lease			
Occupancy	Mark one	<input checked="" type="checkbox"/> Vacant possession	<input type="checkbox"/> Subject to tenancy			
Breach of covenant or unit articles	Description (Insert other breaches)	As disclosed in the Required Documents				
Goods	Description	Fixed Floor Coverings, Light Fittings and Window Treatments as inspected				
Date for Registration of Units Plan						
Date for Completion Within 30 days from the date hereof						
Electronic Transaction? <input type="checkbox"/> No <input checked="" type="checkbox"/> Yes, using Nominated ELN: PEXA						
Land Tax to be adjusted? <input type="checkbox"/> No <input checked="" type="checkbox"/> Yes						
Residential Withholding Tax	New residential premises?		<input checked="" type="checkbox"/> No	<input type="checkbox"/> Yes		
	Potential residential land?		<input checked="" type="checkbox"/> No	<input type="checkbox"/> Yes		
	Buyer required to make a withholding payment?		<input checked="" type="checkbox"/> No	<input type="checkbox"/> Yes (insert details on p.3)		
Foreign Resident Withholding Tax	Relevant Price more than \$750,000.00?		<input type="checkbox"/> No	<input type="checkbox"/> Yes		
	Clearance Certificates attached for all the Sellers?		<input checked="" type="checkbox"/> No	<input type="checkbox"/> Yes		

An agent may only complete the details in this black box and exchange this contract. See page 3 for more information.

Buyer	Full name					
	ACN/ABN					
	Address					
Buyer Solicitor	Firm					
	Email					
	Phone		Ref			
	DX/Address					
Price	Price	\$	(GST inclusive unless otherwise specified)			
	Less deposit	\$	(10% of Price)	<input type="checkbox"/> Deposit by Instalments (clause 52 applies)		
	Balance	\$				
Date of this Contract						

Co-Ownership	Mark one (show shares)	<input type="checkbox"/> Joint tenants	<input type="checkbox"/> Tenants in common in the following shares:
---------------------	------------------------	--	---

Read This Before Signing: Before signing this Contract you should ensure that you understand your rights and obligations. You should read the important notes on page 3. You should get advice from your solicitor.

Seller signature	Buyer signature
Seller witness name and signature	Buyer witness name and signature

Seller Disclosure Documents

The following marked documents are attached and form part of this Contract. The Buyer acknowledges that by execution of this Contract the Buyer certifies in writing that the Buyer received the marked documents prior to entering into this Contract.

- Crown lease of the Land (including variations)
- Current certified extract from the land titles register showing all registered interests affecting the Property
- Deposited Plan for the Land
- Energy Efficiency Rating Statement
- Encumbrances shown on the land titles register (excluding any mortgage or other encumbrance to be discharged)
- If there is an encumbrance not shown on the land titles register — a statement about the encumbrance complying with the Civil Law (Sale of Residential Property) Regulations
- Lease Conveyancing Inquiry Documents for the Property
- Building Conveyancing Inquiry Document (except if:
 - the Property is a Class A Unit
 - the residence on the Property has not previously been occupied or sold as a dwelling; or
 - this Contract is an “off-the-plan purchase”)
- Building and Compliance Inspection Report(s) (except if section 9(2)(a)(ii) or section 9(2)(a)(iii) of the Sale of Residential Property Act applies).
- Pest information (except if the property is a Class A Unit or is a residence that has never been occupied): Pest Inspection Report(s).
- Regulated Swimming Pool documentation required under section 9 (1)(ja) of the Sale of Residential Property Act (on and from 1 May 2024).

If the Property is off-the-plan:

- Proposed plan
- Inclusions list

If the Property is a Unit where the Units Plan is not registered:

- Inclusions list
- Disclosure Statement

If the Property is a Unit where the Units Plan is registered:

- Units Plan concerning the Property
- Current certified extract from the land titles register showing all registered interests affecting the Common Property
- Unit Title Certificate
- Registered variations to rules of the Owners Corporation
- (If the Unit is an Adaptable Housing Dwelling) drawings and plans demonstrating compliance with Australian Standard AS 4299-1995 (Adaptable Housing) as in force from time to time
- (If the Owners Corporation is a party to a Building Management Statement) Building Management Statement

If the Property is a Lot that is part of a Community Title Scheme:

- Section 67 Statement, as first or top sheet
- Community Title Master Plan
- Community Title Management Statement

If the Property is a Lot that will form part of a Community Title Scheme:

- Proposed Community Title Master Plan or sketch plan
- Proposed Community Title Management Statement

GST

- Not applicable
- Input taxed supply of residential premises
- Taxable supply (including new residential premises)
- GST-free supply of going concern
- Margin scheme applies

Tenancy

- Tenancy Agreement
- No written Tenancy Agreement exists

Invoices

- Building and Compliance Inspection Report
- Pest Inspection Report

Asbestos

- Asbestos Advice
- Current Asbestos Assessment Report

Damages for delay in Completion – applicable interest rate and legal costs and disbursements amount (see clause 22)

Interest rate if the defaulting party is the Seller	0% per annum
Interest rate if the defaulting party is the Buyer	10% per annum
Amount to be applied towards legal costs and disbursements incurred by the party not at fault	\$660.00 (GST inclusive)

Tenancy Summary

Premises		Expiry date	
Tenant name		Rent	
Commencement date		Rent review date	
Term		Rent review mechanism	

Managing Agent Details for Owners Corporation or Community Title Scheme (if no managing agent, secretary)

Name		Phone	
Address			

54 AMENDMENTS TO STANDARD TERMS

The standard Terms are amended as follows:

- (a) Clause 2.6 is amended by deleting the words "or in cash (up to \$200.00)".
- (b) Clause 26.2.4 is deleted.
- (c) Clause 51.2 is deleted.
- (d) Clause 52.6 is amended by deleting "14" and inserting "7".

55 ADJUSTMENTS

Despite clause 8.1 if Completion does not occur by the Date for Completion due to the delay or default of the Buyer, the Buyer will be liable on Completion for all Land Charges from and including the Date for Completion.

56 NOTICE TO COMPLETE

A Notice to Complete served by a party may be unilaterally withdrawn or revoked by that party at any time prior to the expiration of the period referred to in the Notice to Complete without prejudicing a Party's right to serve a further notice.

57 NOTICES

57.1 Delivery

If a notice is personally served in accordance with Clause 26.2, the notice is taken to have been received on the day that it is delivered or, if not delivered before 5.00 pm on a Business Day, on the next Business Day.

57.2 Post

If a notice is served by physical post in accordance with Clause 26.2, the notice is taken to have been received on the day 2 Business Days after the day it was posted.

57.3 E-mail

If a notice is served by email in accordance with Clause 26.2, the notice is taken to have been received on the date shown in the delivery receipt produced by the electronic mail system used to send the message and if not delivered before 5.00pm on a Business Day, on the next Business Day.

AUSTRALIAN CAPITAL TERRITORY
TITLE SEARCH

LAND

Fraser Section 46 Block 1 on Deposited Plan 3726

Lease commenced on 26/02/1975, granted on 07/07/1975, terminating on 25/02/2074

Area is 1318 square metres or thereabouts

Proprietor

JOHN WILLIAM DESSENT

34 CARRODUS STREET, FRASER ACT 2615

ALLISON LOUISE JOHNSTON

34 CARRODUS STREET, FRASER ACT 2615

as Joint Tenants

REGISTERED ENCUMBRANCES AND INTERESTS

Original title is **Volume 575 Folio 14**

Restrictions

Purpose Clause: Refer Crown Lease

S.180 Land Act 1991: Compliance/Completion Cert Issued

Registered Date	Dealing Number	Description
16/03/2023	3231251	Mortgage to WESTPAC BANKING CORPORATION (ACN: 007 457 141)

End of interests

ORIGINAL

RESTRICTION ON TRANSFER
SEE CLAUSE 3

EVIDENCE PRODUCED THAT
CERTIFICATE UNDER SEC 28(2A)
C.A.L.O. 1936 ISSUED

Form 'H'

THE COMMONWEALTH OF AUSTRALIA
AUSTRALIAN CAPITAL TERRITORY
City Area Leases Ordinance 1936-1973

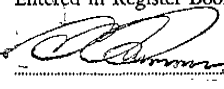
Entered in Register Book Vol. 575 Folio. 14

18 JUL 75 Registrar of Titles

LS 3/26 (12/73)

LEASE GRANTED pursuant to the City Area Leases Ordinance 1936-1973 and the Regulations thereunder on the
seventh day of July One thousand nine hundred and seventy five
WHEREBY the Commonwealth of Australia (hereinafter called the "Commonwealth") grants to ANDRE BALAZS of
31 Lachlan Street Macquarie in the Australian Capital Territory Builder

(hereinafter called the "Lessee")
ALL THAT piece or parcel of land situate in the City Area in the Australian Capital Territory containing an area of 1218 Square Metres
or thereabouts and being Block 1 Section 46 Division of
Fraser as delineated on Deposited Plan Number 3726 in the office of the Registrar of Titles at Canberra
in the said Territory and being the land shown by pink colour on the plan annexed hereto RESERVING unto the Commonwealth all minerals
TO HOLD unto the Lessee for the term of ninety-nine years commencing on the twenty sixth day of February
One thousand nine hundred and seventy five (hereinafter called "the date of the commencement of the lease") to be used
by the Lessee for residential purposes only YIELDING AND PAYING THEREFOR during the said term rent at the rate of five cents per
annum if and when demanded.

1. THE Lessee covenants with the Commonwealth as follows:—

- (a) That the Lessee will pay to the Minister or to the person as may be authorised by the Minister for that purpose at Canberra in the said Territory the rent hereinbefore reserved within one month of the date of any demand made by the Minister relating thereto and served on the Lessee;
- (b) That the Lessee will within one month from the date of the commencement of the lease or within such further time as may be approved in writing by the Commonwealth or the Minister on behalf of the Commonwealth for that purpose commence to erect one private single dwelling house building (with necessary and usual outbuildings and fences) on the said land at a cost not less than the sum of ten thousand dollars and in accordance with plans and specifications prepared by the Lessee and previously submitted to and approved in writing by the Commonwealth or the Minister on behalf of the Commonwealth;
- (c) That the Lessee will within nine months from the date of the commencement of the lease or within such further time as may be approved in writing by the Commonwealth or the Minister on behalf of the Commonwealth complete the erection of the said building at a cost not less than the said sum of ten thousand dollars and in accordance with the said plans and specifications and in accordance with every Statute Ordinance or Regulation applicable thereto;
- (d) That the Lessee will at all times during the said term maintain repair and keep in repair all buildings and erections on the said land all to the satisfaction of the Minister;
- (e) That the Lessee will not without the previous approval in writing of the Commonwealth or the Minister on behalf of the Commonwealth erect any building on the said land or make any structural alterations in any buildings erected on the said land;
- (f) To use the said land for residential purposes only;
- (g) That the building erected on the said land will be used only as a single unit private dwelling house and any outbuildings erected on the said land shall not be used as a habitation;
- (h) If and whenever the Lessee fails to repair or keep in repair any building or erection on the said land the Commonwealth or the Minister on behalf of the Commonwealth may by notice in writing to the Lessee specifying the wants of repairs require the Lessee to effect repairs in accordance with the said notice or to remove the building or erection and if after the expiration of one calendar month from the date of the said notice or such longer time as the Commonwealth or the Minister on behalf of the Commonwealth may in writing allow the Lessee has not effected the said repairs or removed the building or erection the Minister or any person or persons duly authorised by the Commonwealth or the Minister in that behalf with such equipment as is necessary may enter upon the said land and effect the said repairs or (if the Minister is of opinion the building or erection is beyond reasonable repair) may demolish and remove the building or erection and all expenses incurred by the Commonwealth or the Minister in effecting such repairs or in demolishing and removing the building or erection shall be paid by the Lessee to the Commonwealth on demand and from the date of such demand until paid shall for all purposes of this lease be a debt due and payable to the Commonwealth by the Lessee;
- (i) To permit any person or persons authorised by the Minister to enter upon the said land at all reasonable times and in any reasonable manner and inspect the said land and any buildings erections and improvements thereon.

2. THE Commonwealth covenants with the Lessee:—

That the Lessee may at any time upon payment of all rent and other moneys due to and demanded by the Commonwealth under this lease surrender this lease to the Commonwealth but subject to any law of the Territory to the contrary the Lessee shall not be entitled to receive any compensation from the Commonwealth in respect of such surrender or in respect of any buildings erections or improvements upon the said land.

3. IT IS MUTUALLY COVENANTED AND AGREED as follows:—

- (a) That subject to this clause the Lessee will not transfer or assign by way of sale this lease or any interest in this lease whether at law or in equity for five years from the date of the commencement of the lease without the written consent of the Minister first had and obtained;
- (b) That before consenting to any transaction to which this clause applies the Minister may require the Lessee to inform him of any particulars relating to the consideration to be paid in respect of that transaction;
- (c) That a certificate by the Minister that the Lessee may transfer or assign the lease for a consideration not exceeding an amount specified in the certificate shall constitute consent as required by this clause;
- (d) That if the Minister refuses to give consent to the transfer or assignment of this lease the Lessee may make an offer in writing to the Commonwealth to surrender the lease in consideration of payment by the Commonwealth of an amount specified in the offer and the Commonwealth on payment of that amount or an amount agreed upon or in default of an agreement an amount as determined in the next succeeding sub-clause shall accept the surrender of the lease;
- (e) That in the case of a default of agreement referred to above the amount to be paid by the Commonwealth shall be the price paid for the granting of the lease the replacement cost less depreciation of all improvements including landscaping and all expenses properly paid by the Lessee including agent's fees and legal expenses and shall be determined by Arbitration under the laws in force in the Territory relating to Arbitration;
- (f) That when the Commonwealth is required to pay an amount of money in pursuance of this clause it shall first pay out any registered mortgages and pay the balance to the Lessee;
- (g) That any consent given by the Minister is conditional upon the consideration payable in respect of the transaction not exceeding an amount set out in the consent;
- (h) That where a transaction to which this clause applies has been entered into without the consent of the Minister the Commonwealth or the Minister on behalf of the Commonwealth may determine this lease;
- (i) That this clause shall not apply to a transfer or assignment of the lease or of any interest in the lease by operation of law or by will or by a mortgagee in pursuance of a power of sale as mortgagee;
- (j) That when a transaction referred to in sub-clause (a) of this clause has been entered into subject to the consent of the Minister being first obtained the transaction shall not be taken to contravene that sub-clause provided the Minister's consent is applied for within three calendar months after the date of that transaction.

4. IT IS FURTHER MUTUALLY COVENANTED AND AGREED as follows:—

- (a) That if—
 - (i) a building in accordance with sub-clause (b) of clause 1 of this lease is not commenced within the period specified in the said sub-clause; or
 - (ii) a building in accordance with sub-clause (b) of clause 1 of this lease is not completed within the period specified in sub-clause (c) of the said clause; or
 - (iii) after completion of a building as aforesaid the said land is at any time not used for a period of one year for the purpose for which this lease is grantedthe Commonwealth or the Minister on behalf of the Commonwealth may determine this lease but without prejudice to any claim which the Commonwealth or the Minister on behalf of the Commonwealth may have against the Lessee in respect of any breach of the covenants on the part of the Lessee to be observed or performed;
- (b) That acceptance of rent by the Commonwealth or the Minister or a person authorised by the Minister for that purpose during or after any period referred to in paragraph (i) (ii) or (iii) of sub-clause (a) of this clause shall not prevent or impede the exercise by the Commonwealth or the Minister on behalf of the Commonwealth of the powers conferred upon it by sub-clause (a) of this clause;
- (c) If at the expiration of this lease the Minister shall have decided not to subdivide the said land and that it is not required for any Commonwealth purpose and shall have declared the said land to be available for lease the Lessee shall be entitled to a further lease of the said land for such further term and at such rent and subject to such conditions as may then be provided or permitted by Statute Ordinance or Regulation;
- (d) That in this lease the expression "Minister" shall mean the Minister of State of the Commonwealth for the time being administering the City Area Leases Ordinance 1936-1973 including any amendments thereof or any Statute or Ordinance substituted therefor or the member of the Executive Council of the Commonwealth for the time being performing the duties of such Minister and shall include the authority or person for the time being authorised by the Minister or by law to exercise those powers and functions of the Minister;

- (e) That any notice requirement demand consent or other communication to be given to or served upon the Lessee under this lease shall be deemed to have been duly given or served if signed by or on behalf of the Minister and delivered to or sent in a prepaid letter addressed to the Lessee at the said land or at the usual or last-known address of the Lessee or affixed in a conspicuous position on the said land;
- (f) That if the Lessee shall consist of one person the word "Lessee" shall where the context so admits or requires be deemed to include the Lessee and the executors administrators and assigns of the Lessee;
- (g) That if the Lessee shall consist of two or more persons the word "Lessee" shall where the context so admits or requires in the case of a tenancy in common be deemed to include the said persons and each of them and their and each of their executors administrators and assigns and in the case of a joint tenancy be deemed to include the said persons and each of them and the executors administrators and assigns of the survivor of them;
- (h) That if the Lessee shall be a corporation the word "Lessee" shall where the context so admits or requires be deemed to include such corporation and its successors and assigns.

IN WITNESS whereof the Commonwealth and the Lessee have executed this Lease.

SIGNED SEALED AND DELIVERED

by OWEN KEVIN O'MARA
 Delegate of the Minister for and on behalf
 of the Commonwealth in the presence of—

} *Owen Kevin O'Mara*

P. Clark
 Public Servant
 Canberra

SIGNED SEALED AND DELIVERED

by the Lessee in the presence of—

} *A. Bolger*

A. Bolger
 Public Servant
 Canberra

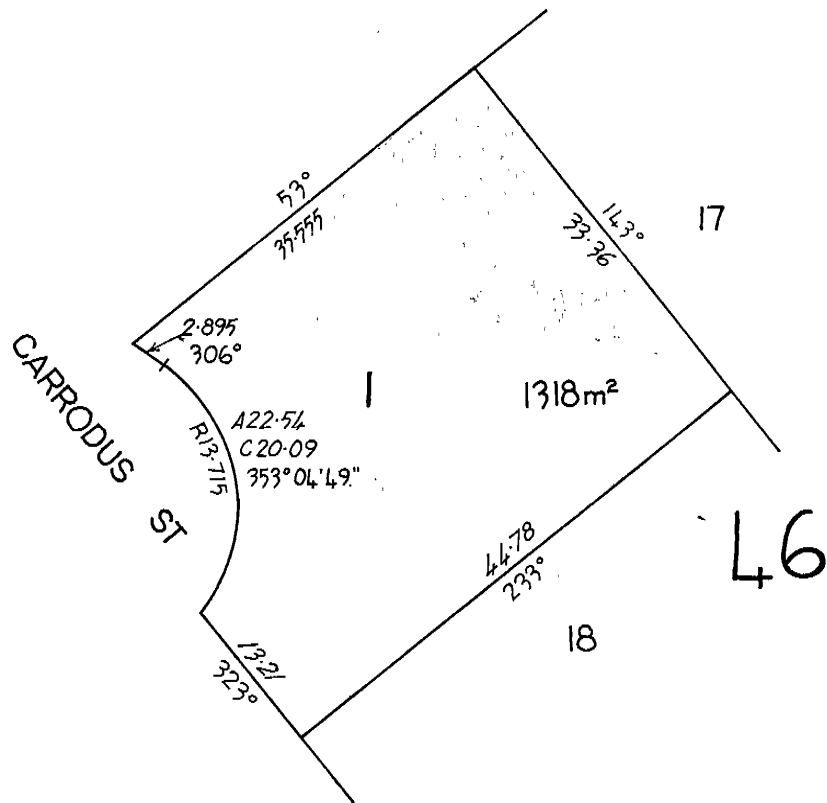

Scale. 1:500

Kevin O'Hara
A. Tolox

"This is the plan referred to in the lease of Block 1 Section 46 Division of Fraser granted on the seventh day of July 1975 as being annexed thereto."

No. 215363 TRANSFER from the Within named Andre Balazs to Michael John Brett of 35 Camodus Place Fraser in the Australian Capital Territory Assistant Manager and Christine Margaret Brett his wife as joint tenants of the land within described

Produced 7th November 1975 and entered 19th February 1976 at ten minutes past five o'clock in the after noon.

Registrar of Titles

No. 517362 DISCHARGE OF MORTGAGE No. 504211

Entered 28th AUGUST 1985 at TEN o'clock in the FORE noon



ALEXANDER Deputy Registrar of Titles

No. 517363 'TRANSFER TO EUGENE QUINN OF 34 CARRODUS STREET FRASER EARTHMOVING CONTRACTOR AND ANNETTE QUINN OF THE SAME ADDRESS HOME DUTIES AS JOINT TENANTS

of the land within described
Entered 28th AUGUST 1985 at TEN o'clock in the FORE noon



ALEXANDER Deputy Registrar of Titles

No. 517364 MORTGAGE TO CANBERRA PERMANENT CO-OPERATIVE BUILDING SOCIETY LIMITED

Entered 28th AUGUST 1985 at TEN o'clock in the FORE noon



ALEXANDER Deputy Registrar of Titles

No. 540442 MORTGAGE TO COMMONWEALTH BANK OF AUSTRALIA

Entered 23rd June 1986 at Three o'clock in the After noon



S. ROBERTSON Deputy Registrar of Titles

No. 730689 CAVEAT

By Adrian Quinn and Olivia Annette Quinn
Entered 29 April 1991 at Ten o'clock in the FORE noon



DEP. REG. P. A. ROWE Deputy Registrar of Titles

No. 736889 WITHDRAWAL OF CAVEAT No. 730689

Entered 14 JUN 1991 at Three o'clock in the After noon.



P. A. ROWE Deputy Registrar of Titles

No. 736890 DISCHARGE OF MORTGAGE No. 517364

Entered 14 JUN 1991 at Three o'clock in the After noon



P. A. ROWE Deputy Registrar of Titles

No. 736891 DISCHARGE OF MORTGAGE No. 540442
Entered 14 JUN 1991 at Three o'clock in the After noon.



P. A. ROWE Deputy Registrar of Titles

No. 736892 TRANSFER TO Christopher Nicol STEWART and Tracey Louise STEWART as joint tenants of the land within described

Entered 14 JUN 1991 at Three o'clock in the After noon.



P. A. ROWE Deputy Registrar of Titles

No. 215364 MORTGAGE from the Said Michael John Brett and Christine Margaret Brett to Commissioners for Housing

Produced 7th November 1975 and entered 19th February 1976 at ten minutes past five o'clock in the after noon.

Registrar of Titles

No. 215365 MORTGAGE from the Said Michael John Brett and Christine Margaret Brett to The National Bank Savings Bank Limited

Produced 7th November 1975 and entered 19th February 1976 at thirty minutes past five o'clock in the after noon.

Registrar of Titles

No. 379762 Mortgage from Michael John Brett now Manager and Christine Margaret Brett to ACT Hospitals and Health Employees Credit Union Co-operative Limited
Entered 15th September 1981 at NINE o'clock in the FORE noon



Registrar of Titles

No. 504210 DISCHARGE OF MORTGAGE No. 379762

Entered 24th April 1985 at Two o'clock in the after noon



M. N. SAVY Deputy Registrar of Titles

No. 504211 mortgage to National Australia Bank Limited

Entered 24th April 1985 at Two o'clock in the after noon



M. N. SAVY Deputy Registrar of Titles

No. 517360 DISCHARGE OF MORTGAGE No. 215364

Entered 28th AUGUST 1985 at TEN o'clock in the FORE noon



M. ALEXANDER Deputy Registrar of Titles

No. 517361 DISCHARGE OF MORTGAGE No. 215365

Entered 28th AUGUST 1985 at TEN o'clock in the FORE noon



M. ALEXANDER Deputy Registrar of Titles

MORTGAGE TO STATE BANK OF NEW SOUTH WALES LIMITED
Entered 14 JUN 1991 at Three o'clock in the after noon.
P. A. ROWE Deputy Registrar of Titles

CANCELLED & CERTIFICATE OF TITLE VOLUME 1365 FOLIO 3 ISSUED
P. A. ROWE Deputy Registrar of Titles

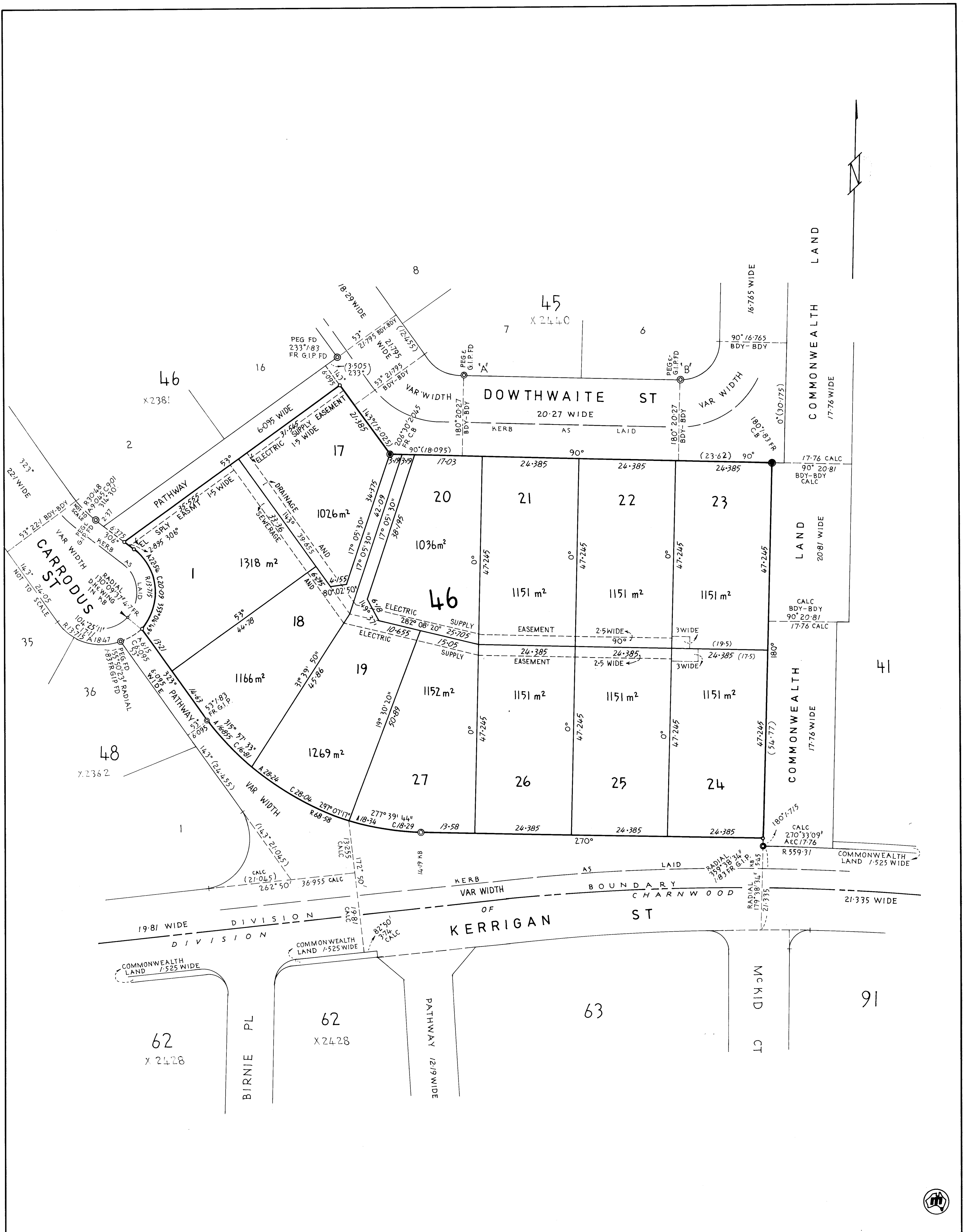

REFERENCE MARKS

⊙ Denotes G.I.P. in road 1:83 radially from T.P.
 ⊙ " C.B. " " 1:83 " " T.P. (Except as otherwise shown)

Azimuth: A-B (Strom)

I, KAZIMIERZ FELICJAN MICHNIEWICZ of CANBERRA a surveyor registered under the Surveyors Ordinance 1967-1970 hereby certify that the survey represented on this plan is accurate and has been made (1) by me (2) under my immediate supervision in accordance with Survey Practice Directions 1972 and was completed on 5-9-1974.

(Signature) *K. Michniewicz*
 Surveyor registered under the Surveyors Ordinance 1967-1970.

I certify that this plan is the plan prepared in accordance with Section 6 of the Districts Ordinance 1966-1967.

(Signature) *[Signature]* 30.2.74
 Surveyor General for Australia / Commonwealth Surveyor-General

PLAN OF
BLOCKS 1,17-27, SECTION 46

DIVISION: FRASER
DISTRICT: CANBERRA CITY

AUSTRALIAN CAPITAL TERRITORY

10 5 0 SCALE 1:500 20 30 METRES

Field Books: K7135 71/4361

Deposited in the office of the Registrar of Titles at Canberra in the Australian Capital Territory the Fourth day of October 1974 at Ten minutes past ten o'clock in the forenoon.

Approved *[Signature]*
 Registrar of Titles.

DEPOSITED PLAN
3726



LEASE CONVEYANCING ENQUIRY

Your response is sought to the following questions in relation to:

LAND: Please provide details of the land you are enquiring about.

Unit	0	Block	1	Section	46	Suburb	FRASER
-------------	----------	--------------	----------	----------------	-----------	---------------	---------------

Leased by the Australian Capital Territory on behalf of the Commonwealth under the Land (Planning and Environment) Act 1991, Planning & Development Act 2007 and Planning Act 2023.

- | | No | Yes |
|--|-----------|------------------|
| 1. Have any notices been issued relating to the Crown Lease? | (X) | () |
| 2. Is the Lessor aware of any notice of a breach of the Crown Lease? | (X) | () |
| 3. Has a Certificate of Compliance been issued? (N/A ex-Government House) <input type="checkbox"/> | () | (X) |
| Certificate Number: A7914 | | Dated: 06-NOV-75 |
| 4. Has an application for Subdivision been received under the Unit Titles Act? | | (see report) |
| 5. Has the Property been nominated for provisional registration, provisionally registered or registered in accordance with provisions of the Heritage Act 2004? | | (see report) |
| 6. If an application has been determined, is the land subject to an Environmental Impact Statement under Chapter 8 of the Planning & Development Act 2007, or part 6.3 of the Planning Act 2023? | | (see report) |
| 7. Has a development application been received, or approval (applications lodged prior to 2 April 1992 will not be included)? | | (see report) |
| 8. Has an application been received or approved for Dual Occupancy? (applications lodged prior to 2 April 1992 will not be included) | | (see report) |
| 9. Has an Order been made in respect of the Land pursuant to Part 11.3 of the Planning & Development Act 2007 or Part 12.3 of the Planning Act 2023? | | (see report) |
| 10 Contaminated Land Search - Is there information recorded by Environment ACT regarding the contamination status of the land? | | (see report) |

Date: 19-MAR-26 12:22:37

Applicant's Name : Ng Chok, Deanna
 E-mail Address : deanna@bedfordslegal.com.au
 Client Reference : 131136 Johnston



ACCESS CANBERRA
 LAND, PLANNING & BUILDING SERVICES
 8 Darling Street
 MITCHELL ACT 2911

19-MAR-2026 12:22

PLANNING AND LEASE MANAGER (PaLM)
LEASE CONVEYANCING ENQUIRY REPORT

Page 1 of 2

INFORMATION ABOUT THE PROPERTY

FRASER Section 46/Block 1

Area(m2): 1,318.8
Unimproved Value: \$499,000 **Year:** 2025
Subdivision Status: Application not received under the Unit Titles Act.
Heritage Status: Nil.

Environment Assessment: The Land is not subject to an Environmental Impact Statement under Chapter 8 of the Planning & Development ACT 2007, or part 6.3a of the Planning Act 2023.

DEVELOPMENT APPLICATIONS ON THE PROPERTY (SINCE APRIL 1992)

Application DA20006466 **Lodged** 20-OCT-00 **Type** Single Dwelling

-- Application Details -----

Description

Additions (Garage with Two Bedrooms above) to Residence

-- Site Details -----

District	Division	Section	Block(s)	Unit
Belconnen	Fraser	46	1-1	

-- Involved Parties -----

Role	Name
Applicant	Barr

-- Activities -----

Activity Name	Status
Ba Single Hse (Neighbour Cons)	Approved

DEVELOPMENT APPLICATIONS ON THE ADJACENT PROPERTIES (LAST 2 YEARS ONLY)

The information on development applications on adjacent blocks is to assist purchasers to be aware of possible nearby development activity. Please note however, it doesn't cover all development activity. Exempt activities can include but are not limited to, new residences, additions to residences, certain sheds, carports and pergolas etc. Information on exempt developments can be found at <https://www.planning.act.gov.au/applications-and-assessments/development-applications/check-if-you-need-a-da>



ACCESS CANBERRA
LAND, PLANNING & BUILDING SERVICES
8 Darling Street
MITCHELL ACT 2911

19-MAR-2026 12:22

PLANNING AND LEASE MANAGER (PaLM)
LEASE CONVEYANCING ENQUIRY REPORT

Page 2 of 2

LAND USE POLICIES

To check the current land use policy in the suburb that you are buying a property in, please check the Territory Plan online at <https://www.legislation.act.gov.au/ni/2023-540/>

CONTAMINATED LAND SEARCH

Information is not recorded by the Environment Protection Authority regarding the contamination status of this land. However, this does not absolutely rule out the possibility of contamination and should not be interpreted as a warranty that there is no contamination. To be completely sure, independent tests should be arranged.

ASBESTOS SEARCH

ACT Government records indicate that asbestos (loose fill or otherwise) is not present on this land. However, the accuracy of this information is not guaranteed. If the property was built prior to 1 January 2004, you should make your own enquiries and obtain reports (from a licensed Asbestos Assessor) in relation to the presence of loose-fill asbestos insulation (and other forms of asbestos e.g. bonded asbestos) on the premises.

CAT CONTAINMENT AREAS

Cat containment has been extended across the ACT for cats born on or after 1 July 2022. Containment means keeping your cat on your premise 24 hours a day. This can include your house or apartment, enclosed area in a backyard or courtyard, a cat crate or leash. Cats born before 1 July 2022 do not have to be contained unless they live in one of the 17 currently declared cat containment suburbs. All cats (regardless of age) located in the following suburbs must be contained to their premise 24 hours a day. However, cats can be walked on a leash and harness under effective control in all containment suburbs: BONNER, COOMBS, CRACE, DENMAN PROSPECT, FORDE, JACKA, LAWSON, MOLONGLO, MONCRIEFF, STRATHNAIRN, THE FAIR in north WATSON, THROSBY, WRIGHT, GUNGAHLIN TOWN CENTRE, MACNAMARA, TAYLOR and WHITLAM. More information on cat containment is available at <https://www.cityservices.act.gov.au/pets-and-wildlife/domestic-animals/cats/cat-containment> or by phoning Access Canberra on 13 22 81.

URBAN FOREST ACT 2023

The Urban Forest Act 2023 (or Tree Protection Act 2005 where applicable) protects individual trees of importance and urban forest areas that require particular protection. A Tree Register has been established and can be found on the Transport Canberra and City Services website https://www.cityservices.act.gov.au/trees-and-nature/trees/act_tree_register or for further information please call Access Canberra on 132281.

----- END OF REPORT -----



Residential REPORTS



PRESALE REPORT

34 Carrodus Street

Fraser

REPORT PREPARED

18 March 2026



35 Poynton Street Hughes



6288 0402



info@residentialreports.com.au

SITE RECORD

ADDRESS	34 Carrodus Street Fraser	
CLIENT	John Dessent & Allison Johnston	
OCCUPANCY STATUS	occupied - the dwelling was furnished at the time of inspection	
INSPECTOR - Derek Taylor	INSPECTION DATE - 17 March 2026	WEATHER CONDITIONS - Fine
JOB REFERENCE - 46231	BLOCK - 1	SECTION - 46

INSPECTION DATA SUMMARY

YEAR OF DEVELOPMENT (APPROX. ISSUE OF FIRST CERTIFICATE OF OCCUPANCY)	<ul style="list-style-type: none">1975
AREA DETAILS (APPROX. SQM)	<ul style="list-style-type: none">Residence - 226.5sqmGarage - 65.5sqmBlock size - 1318sqm
WALL CONSTRUCTION	<ul style="list-style-type: none">brick veneer, timber framed with fibrous cement cladding to the upper level
ROOF CONSTRUCTION	<ul style="list-style-type: none">timber truss construction corrugated metal roof covering
FLOOR CONSTRUCTION	<ul style="list-style-type: none">timber bearers and joists with tongue and groove flooringconcrete slab construction
ENERGY RATING	<ul style="list-style-type: none">3 stars
CONSTRUCTION	<ul style="list-style-type: none">the dwelling is of adequate construction and structural workmanship for this type of residential development and its condition is commensurate with the era of construction, design, age and use
MAINTENANCE	<ul style="list-style-type: none">there are maintenance items detailed in this report, please read the entire report
TIMBER PEST REPORT	<ul style="list-style-type: none">please review the entire report, including the <i>Timber Pest Overview and Recommendations</i> section, for complete details and contextno evidence of active subterranean termites (live species) was found at the time of our inspection
COMPLIANCE REPORT	<ul style="list-style-type: none">For details on structures in this block and section, see the compliance report

IMPORTANT: *This report is intended to be read in its entirety. You must carefully read the full document including Detailed Inspection Information, Warranty & Use and Scope & Limitations prior to making any critical decisions.* The above Data Summary is supplementary to the Report and should not be used as a standalone reference. It is imperative to review the complete Report and in the case of any discrepancies between the Report and the above comments, the information in the detailed Report is the final authority. The reader is requested to immediately contact us if any content is not fully understood and requires clarification or further explanation. We value the opportunity to work on this inspection project and wish you all the best as you evaluate this property.

Signed on behalf of:

[Residential Reports Pty Limited ABN 38 609 880 122](#)

Derek Taylor

Derek Taylor

Building & Timber Pest Assessor

INSPECTION SCOPE – INTRODUCTION FOR THE READER

The reader must refer to the comprehensive Warranty & Use and Scope & Limitations at the end of this report. This report is written with reference to the Australian Standards outlined in our Scope & Limitations and is the result of a largely visual inspection only as required by the Standards. The inspection has been conducted to identify notable defects, insofar as an inspector can reasonably identify them and considering the building's age. Comments are provided primarily for items that could impact property value, normal wear and tear for an older building may not be detailed. If there are any discrepancies between the "Summary" and the Detailed Report, the Detailed Report should be relied upon. Where testing is undertaken and there are adverse findings, details will be noted. We do not inspect features such as electrical appliances, utilities, or swimming pool/s and equipment; qualified technicians should be consulted. This report does not quantify ongoing maintenance, upgrades, cosmetic works, or minor defects. If present, significant defects will be noted, and further investigation may be recommended. Where reference has been made to termites (live species, activity or prior activity) and maintenance or defects of significance, we strongly advise that prior to making any critical decisions, that the services of a suitably qualified tradesperson be engaged to quantify remedial action. Report comments may seem repetitive to emphasise that all inspected elements have been reviewed and a summary of inspection items is included at the end of the report for your reference.

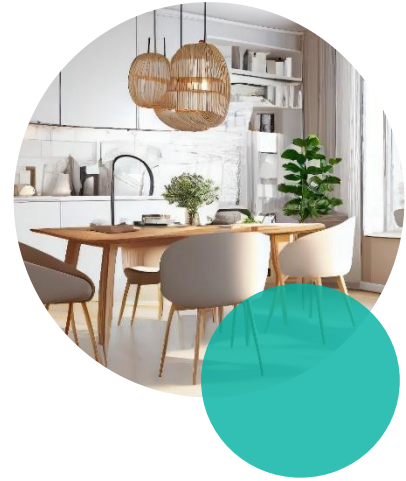

STANDARD INDICATORS EXPLAINED

Our Inspector uses the terms below to describe the condition of building elements. The inspection is visual and conducted under normal lighting. These terms consider factors like the building's age, construction quality and type. Keep in mind that what is considered "good" may vary between an older and a modern building. There are no estimates for repair costs reported, as these depend on your service provider and chosen action:

GOOD	The feature is generally in good condition and does not require major repairs. Minor imperfections in the finish or structure may be present. For elements like windows and doors, the observation refers to a visual inspection only, focusing on substantial defects affecting the property, not operational issues.
FAIR	The feature is functional but has deteriorated and would benefit from cosmetic or remedial repair work.
POOR	The feature in the inspector's opinion, requires remedial action. Repairs or replacement are considered necessary rather than discretionary.
NO SIGNIFICANT DEFECTS	This condition is applied when no significant structural or functional defects are observed. Minor issues may be present, and any remedial action is discretionary.
DEFECTS HAVE BEEN IDENTIFIED	This condition is applied where the inspector has identified defects that require remedial action or investigation considered necessary rather than discretionary.



IMPORTANT NOTE

Your inspector has conducted a comprehensive visual site assessment following Australian Standards for the Building Report and Timber Pest Report. Whilst the reports are considered separate, we've organised all the data for each area into a single table for your convenience. For example, when commenting on fences, you'll find information on both building maintenance and pest considerations in the one table. Where suspected water leakage, termite activity, active or latent, or building defects have been identified in this report, we strongly suggest further investigation. **The reader must refer to the comprehensive Warranty & Use and Scope & Limitations contained in this report as it contains important advice for intending purchasers and for the owner of this building.** A proactive approach to building maintenance and timber pest management is essential to the upkeep of the property.

INTERIOR

Entrance

ceilings and cornices	good
architraves and skirting boards	good
walls	good
doors and windows internal	good

Bedroom One

ceilings and cornices	good
architraves and skirting boards	good
walls	good
doors and windows internal	good

Bedroom Two

ceilings and cornices	fair to good <ul style="list-style-type: none"> there are some undulations to the ceiling lining - however, this was not considered structurally significant at the time of our inspection there are visible repairs to the ceiling lining. This was considered to be of cosmetic significance only. Further repairs are discretionary
architraves and skirting boards	good
walls	good
doors and windows internal	good

Bedroom Three

ceilings and cornices	fair to good <ul style="list-style-type: none"> there is some minor cracking along the cornice line in some areas there are some undulations to the ceiling lining - however, this was not considered structurally significant at the time of our inspection
architraves and skirting boards	good
walls	fair to good <ul style="list-style-type: none"> there are visible repairs to the wall lining. This was considered to be of cosmetic significance only. Further repairs are discretionary
doors and windows internal	good

Bedroom One (Upper Floor)

ceilings and cornices	good
architraves and skirting boards	good
walls	good
doors and windows internal	good

Bedroom Two (Upper Floor)

ceilings and cornices	good
architraves and skirting boards	good
walls	good
doors and windows internal	good

Ensuite (Bedroom Two)

ceilings and cornices	fair to good <ul style="list-style-type: none"> there is some minor cracking along the cornice line in some areas
architraves and skirting boards	good
walls	good
doors and windows internal	fair to good <ul style="list-style-type: none"> the latchset requires minor adjustment
vanity/hand basin	fair to good <ul style="list-style-type: none"> the sink unit has deteriorated commensurate with its age, however it remains serviceable
shower screen	good
toilet suite	good
ventilation	<ul style="list-style-type: none"> ceiling fan unit (with heat lamps)
water leakage	<ul style="list-style-type: none"> no water leakage detected in accessible areas
wall tiles	good
floor tiles	fair to good <ul style="list-style-type: none"> replacement of the seal at the intersection between the wall and floor tiles is recommended
fit-out	good
hardware, fixtures and fittings	good

Bathroom and Toilet	
ceilings and cornices	good
architraves and skirting boards	good
walls	good
doors and windows internal	fair to good <ul style="list-style-type: none"> the door has been affected by water penetration, repair or replacement is recommended
vanity/hand basin	good
shower screen	fair to good <ul style="list-style-type: none"> moisture has penetrated between the laminated glass. This is a deteriorating defect and it will worsen over time
bath	good <ul style="list-style-type: none"> spa bath - the pump has not been tested
ventilation	<ul style="list-style-type: none"> ceiling fan unit (with heat lamps)
toilet suite	good
water leakage	<ul style="list-style-type: none"> no water leakage detected in accessible areas
wall tiles	fair to good <ul style="list-style-type: none"> there are imperfections to the wall tiling from a previous installation the wall tiles have been painted
floor tiles	fair to good <ul style="list-style-type: none"> replacement of the seal at the intersection between the wall and floor tiles is recommended
fit-out	good
hardware, fixtures and fittings	good

Laundry	
ceilings and cornices	good
architraves and skirting boards	good
walls	good
doors and windows internal	good
laundry tub	fair to good <ul style="list-style-type: none"> there are water stains visible underneath the sink to the wall. We are unable to determine if there is any ongoing water leakage, however, the area was dry at the time of inspection
water leakage	<ul style="list-style-type: none"> no water leakage detected in accessible areas
ventilation	<ul style="list-style-type: none"> there is no mechanical ventilation
wall tiles	good
floor tiles	good <ul style="list-style-type: none"> there are no floor tiles, the floor is covered with vinyl flooring
hardware, fixtures and fittings	good

Kitchen and Family Area

ceilings and cornices	fair to good <ul style="list-style-type: none">• there are water stains on the ceiling, electronic moisture meter testing and our visual inspection did not identify any current water leakage at the time of inspection. It is not possible to determine when the leakage occurred, and under what circumstances, or to eliminate the possibility of further leakage in the future, we recommend monitoring changes and consulting a suitably qualified expert if required• there are some undulations to the ceiling lining - however, this was not considered structurally significant at the time of our inspection
architraves and skirting boards	good
walls	good
doors and windows internal	good
sink	good
splashback	good
ventilation	<ul style="list-style-type: none">• ventilation is provided by an externally ducted range hood
hardware, fixtures and fittings	good
kitchen fit-out	good

Family Room (Extension)

ceilings and cornices	fair to good <ul style="list-style-type: none">• there are some undulations to the ceiling lining - however, this was not considered structurally significant at the time of our inspection
architraves and skirting boards	good
walls	good
doors and windows internal	good
fireplace/solid fuel heater	<ul style="list-style-type: none">• there is a solid fuel heater installed in this area (unit not tested for safety or operation)

Living Room

ceilings and cornices	fair to good <ul style="list-style-type: none">• there are some undulations to the ceiling lining - however, this was not considered structurally significant at the time of our inspection• there are visible repairs to the ceiling lining. This was considered to be of cosmetic significance only. Further repairs are discretionary• there are paint defects to the ceiling lining
architraves and skirting boards	good
walls	good
doors and windows internal	good

Hallway

ceilings and cornices	good
architraves and skirting boards	good
walls	fair to good <ul style="list-style-type: none">• there is impact damage to the wall linings in some areas
doors and windows internal	good

Steps, Stairs and Landing Area	
steps and stairs internal	good
balustrades and handrails	good
ceilings and cornices	good
walls	fair to good <ul style="list-style-type: none"> • there are visible repairs to the wall lining. This was considered to be of cosmetic significance only. Further repairs are discretionary

Roof Cavity	
insulation	<ul style="list-style-type: none"> • the roof cavity is insulated with fibreglass batts
sarking	<ul style="list-style-type: none"> • insulated sarking has been installed in the roof cavity
roof construction	<ul style="list-style-type: none"> • timber truss construction
termites - roof void	<ul style="list-style-type: none"> • no active termites and/or termite damage or workings were observed in the areas accessible at the time of inspection
wood decay - roof void	<ul style="list-style-type: none"> • no evidence of wood decay (rot) fungi damage was sighted in areas accessible at the time of inspection
borers - roof void	<ul style="list-style-type: none"> • no evidence of borer damage was sighted in areas accessible at the time of the inspection

Interior/Main Dwelling	
termites - interior	<ul style="list-style-type: none"> • no active termites and/or termite damage or workings were observed in the areas accessible at the time of inspection
wood decay - interior	<ul style="list-style-type: none"> • no evidence of wood decay (rot) fungi damage was sighted in areas accessible at the time of inspection
borers - interior	<ul style="list-style-type: none"> • no evidence of borer damage was sighted in areas accessible at the time of the inspection

Inspection Items	
roof exterior	no significant defects <ul style="list-style-type: none"> • corrugated metal roof covering
gutters and downpipes	defects have been identified <ul style="list-style-type: none"> • there is leakage occurring at some gutter and or downpipe section joins. Remedial action may include sealing of the leak with an appropriate sealant. Monitoring and maintenance of guttering is recommended to ensure optimum performance • gutters need to be cleared of leaf litter, silt and debris to ensure that maximum roof drainage occurs in all weather conditions. Additionally, the leaf litter may be concealing rust or defects
eaves, fascia and barge ends	no significant defects
wall construction exterior	no significant defects <ul style="list-style-type: none"> • brick veneer, timber framed with fibrous cement cladding to the upper level • our inspection did not identify any cracks in the exterior masonry that were considered to be structurally significant. Cracking of masonry walls is very common, particularly given the clay soil substrate found in this region. Cracks that were considered to have no structural implications have not been individually identified
doors and windows external	no significant defects
floor construction	no significant defects <ul style="list-style-type: none"> • timber bearers and joists with tongue and groove flooring • concrete slab construction • there is no evidence that the floor has any significant defects, floor coverings prohibit a visual inspection so it is possible that some minor defects may be concealed
driveway	no significant defects <ul style="list-style-type: none"> • there is some movement cracking in the driveway
paths and paving	no significant defects <ul style="list-style-type: none"> • there is some minor cracking to the paths
steps and stairs external	no significant defects
retaining walls	no significant defects
grounds	no significant defects
swimming pool or spa	<ul style="list-style-type: none"> • the swimming pool, filtration equipment and safety fencing, gates and other aspects of swimming pool safety are not included in this report. A self closing, self latching gate is present, however, extensive testing has not been performed. To obtain specific information relative to these items and advice regarding optimum pool safety barrier systems it will be necessary to commission an inspection by a suitably qualified technician. Safety requirements are not related to the specifications contained in the current Building Code of Australia • For more information: visit residentialreports.com.au, click on 'resource library' and refer to the publication - Swimming Pool and Spa Regulations & Swimming Pool and Spa Safety

fences and gates	<p>no significant defects</p> <ul style="list-style-type: none"> • vegetation and screening in some areas of the fence line limited our inspection. We were unable to determine the condition of the fencing in those areas • impact damage was evident to some areas of the metal fencing, repair is considered discretionary
------------------	--

Subfloor	
subfloor access and general	<ul style="list-style-type: none"> • our inspection was restricted by low clearances
subfloor drainage & ventilation	<ul style="list-style-type: none"> • whilst we are not plumbers, our inspection indicates that the subfloor drainage and ventilation is generally fair, inadequate drainage can lead to an environment conducive to timber pests, and improvement options such as vent airflow should be considered
termites - subfloor	<ul style="list-style-type: none"> • no active termites and/or termite damage or workings were observed in the areas accessible at the time of inspection
wood decay - subfloor	<ul style="list-style-type: none"> • evidence of wood decay fungi (wood rot) was found in, but not necessarily limited to, the areas noted below; • timber off cuts lying on the ground • damage in the area/s noted appears to be moderate
borers - subfloor	<ul style="list-style-type: none"> • visible evidence of borer damage was found in, but not necessarily limited to, the areas noted below; • a number of joists • damage in the area/s noted appears to be slight

Garage	
description	<ul style="list-style-type: none"> • double garage with internal access
roof exterior	no condition has been applied <ul style="list-style-type: none"> • living area above
gutters and downpipes	good
wall construction exterior	fair to good <ul style="list-style-type: none"> • brick construction • there is movement cracking in the exterior masonry, while the cracks were not considered to be structurally significant at the time of our inspection, they should be monitored over time to ensure that there is no ongoing movement
floor construction	no condition has been applied <ul style="list-style-type: none"> • concrete slab construction • there is no evidence that the floor has any significant defects, floor coverings prohibit a visual inspection so it is possible that some minor defects may be concealed
doors	good <ul style="list-style-type: none"> • one panel lift door has been fitted
ceilings and cornices	fair to good <ul style="list-style-type: none"> • there are some undulations to the ceiling lining - however, this was not considered structurally significant at the time of our inspection • there are visible repairs to the ceiling lining. This was considered to be of cosmetic significance only. Further repairs are discretionary
doors and windows internal	good
termites - garage	<ul style="list-style-type: none"> • no active termites and/or termite damage or workings were observed in the areas accessible at the time of inspection
wood decay - garage	<ul style="list-style-type: none"> • no evidence of wood decay (rot) fungi damage was sighted in areas accessible at the time of inspection
borers - garage	<ul style="list-style-type: none"> • no evidence of borer damage was sighted in areas accessible at the time of the inspection
walls	good

Carport	
carport type	<ul style="list-style-type: none"> • single carport
roof exterior	good <ul style="list-style-type: none"> • metal deck roof covering
gutters and downpipes	fair to good <ul style="list-style-type: none"> • an endcap to the guttering is missing
structural integrity	good
termites - carport	<ul style="list-style-type: none"> • no active termites and/or termite damage or workings were observed in the areas accessible at the time of inspection
wood decay - carport	<ul style="list-style-type: none"> • no evidence of wood decay (rot) fungi damage was sighted in areas accessible at the time of inspection
borers - carport	<ul style="list-style-type: none"> • no evidence of borer damage was sighted in areas accessible at the time of the inspection

Deck and Pergola	
decking timbers	<p>good</p> <ul style="list-style-type: none"> the deck substrate timbers could not be inspected because of the low clearance to the ground. However, our inspection indicated that there are no significant structural problems
deck support posts	<p>no condition has been applied</p> <ul style="list-style-type: none"> we were unable to inspect all areas of the deck substrate, therefore we cannot comment on the overall condition of posts that are not visible
structural integrity	<ul style="list-style-type: none"> we are of the opinion that the deck is able to withstand normal weight loadings. However, we recommend that weight loads beyond normal use be avoided. Failure under excessive loads may result in serious injury. The deck structure should be regularly inspected to ensure that its structural integrity is maintained
termites - deck pergola	<ul style="list-style-type: none"> no active termites and/or termite damage or workings were observed in the areas accessible at the time of inspection
wood decay - deck pergola	<ul style="list-style-type: none"> no evidence of wood decay (rot) fungi damage was sighted in areas accessible at the time of inspection
borers - deck pergola	<ul style="list-style-type: none"> no evidence of borer damage was sighted in areas accessible at the time of the inspection
pergola roof	<p>good</p> <ul style="list-style-type: none"> corrugated metal roof

Deck (Off laundry)	
decking timbers	<p>good</p> <ul style="list-style-type: none"> the deck substrate timbers could not be inspected because of the low clearance to the ground. However, our inspection indicated that there are no significant structural problems
deck support posts	<p>good</p> <ul style="list-style-type: none"> we were unable to inspect all areas of the deck substrate, therefore we cannot comment on the overall condition of posts that are not visible
structural integrity	<ul style="list-style-type: none"> we are of the opinion that the deck is able to withstand normal weight loadings. However, we recommend that weight loads beyond normal use be avoided. Failure under excessive loads may result in serious injury. The deck structure should be regularly inspected to ensure that its structural integrity is maintained
termites - deck pergola	<ul style="list-style-type: none"> no active termites and/or termite damage or workings were observed in the areas accessible at the time of inspection
wood decay - deck pergola	<ul style="list-style-type: none"> no evidence of wood decay (rot) fungi damage was sighted in areas accessible at the time of inspection
borers - deck pergola	<ul style="list-style-type: none"> no evidence of borer damage was sighted in areas accessible at the time of the inspection

Covered Alfresco	
decking timbers	<p>good</p> <ul style="list-style-type: none"> the deck substrate timbers could not be inspected because of the low clearance to the ground. However, our inspection indicated that there are no significant structural problems
deck support posts	<p>no condition has been applied</p> <ul style="list-style-type: none"> we were unable to inspect all areas of the deck substrate, therefore we cannot comment on the overall condition of posts that are not visible
structural integrity	<ul style="list-style-type: none"> we are of the opinion that the deck is able to withstand normal weight loadings. However, we recommend that weight loads beyond normal use be avoided. Failure under excessive loads may result in serious injury. The deck structure should be regularly inspected to ensure that its structural integrity is maintained
termites - deck pergola	<ul style="list-style-type: none"> no active termites and/or termite damage or workings were observed in the areas accessible at the time of inspection
wood decay - deck pergola	<ul style="list-style-type: none"> no evidence of wood decay (rot) fungi damage was sighted in areas accessible at the time of inspection
borers - deck pergola	<ul style="list-style-type: none"> no evidence of borer damage was sighted in areas accessible at the time of the inspection
gutters and downpipes	good
pergola roof	<p>good</p> <ul style="list-style-type: none"> metal deck roof

Entrance Patio	
patio construction	<p>fair to good</p> <ul style="list-style-type: none"> tiled floor construction there are cracked tiles in some areas
drainage	<p>good</p> <ul style="list-style-type: none"> drainage appears to be directed away from the dwelling, however, this was not tested at the time of inspection

TIMBER PEST - OVERVIEW & RECOMMENDATIONS

Overall risk - pest	<ul style="list-style-type: none"> considering all of the relevant factors, it is our opinion that the overall degree of risk of timber pest infestation to the property is MODERATE to HIGH - we strongly recommend that regular inspections are undertaken
Evidence of timber pests	<ul style="list-style-type: none"> no evidence of active subterranean termites (live species) was found at the time of our inspection
Evidence of a termite nest	<ul style="list-style-type: none"> no, please read the report in full
Evidence of a pest treatment	<ul style="list-style-type: none"> we found no evidence of any recent termite treatment or durable notice at the time of inspection
Pest treatment required?	<ul style="list-style-type: none"> considering there is no evidence of a pest treatment, we recommend that a regular pest management program in accordance with Australian Standard 3660.1 to prevent subterranean termites from infesting the property be implemented. A proactive approach to Timber Pest Management will offer the highest protection for the building. A management proposal can be obtained by contacting our office on 6288 0402, or please contact your regular inspector.
We recommend pest inspections are conducted every:	<ul style="list-style-type: none"> 6 to 12 months
Drainage and ventilation	<ul style="list-style-type: none"> whilst we are not plumbers, it is considered that the drainage is generally fair
Mould	<ul style="list-style-type: none"> mould was not observed at time of inspection <p>Mould on walls and ceilings etc; is an indicator of high moisture or very poor ventilation. If reported you should commission further investigation by a builder or an Industry Hygienist as its presence may indicate a water leak, wood decay or termites behind the wall or ceiling sheeting.</p>
Weep holes	<p>Were the weep holes clear allowing the free flow of air?</p> <ul style="list-style-type: none"> not applicable, suspended timber floor construction <p>Weep holes are small openings that allow water to drain from within an assembly. Weeps are located at the bottom of the building to allow for drainage. It is important that soil, lawn, concrete paths or pavers do not cover the weep holes. Sometimes they have been covered during the rendering of the brick work. They should be clean and free flowing. Covering the weep holes in part or in whole may allow undetected termite entry.</p>
Slab edge exposure	<p>Is the slab edge exposed?</p> <ul style="list-style-type: none"> not applicable, suspended timber floor construction <p>Where external concrete slab edges are not exposed there is a high risk of concealed termite entry. In some buildings built since July 1995 the edge of the slab forms part of the termite shield system. In these buildings an inspection zone of at least 75mm should be maintained to permit detection of termite entry. The concrete edge should not be concealed by render, tiles, cladding, flashings, adjoining structures, paving, soil, turf or landscaping etc. Where this is the case, you should arrange to have the slab edge exposed for inspection. Concealed termite entry may already be taking place but could not be detected at the time of the inspection. This may result in concealed timber damage.</p>

Termite shields (ant caps) cont.	<p>In our opinion the termite shields appear to be:</p> <ul style="list-style-type: none"> adequate <p>Termite Shields should be in good order so termite workings are exposed and visible. This helps stop termites gaining undetected entry. Joints in the shielding should have been soldered or sealed with an approved sealant as per AS 3660 during the installation. Whenever it is observed that the joints in the shielding have not been soldered then the shielding must be reported as inadequate. It may be possible for a builder to repair the shielding. If not, a chemical treated zone may need to be installed to deter termites from gaining concealed access to the building. Missing, damaged or poor shields increase the risk of termite infestation. Other physical shield systems are not visible to inspection and no comment is made on such systems.</p>
Hot water, air conditioning and water tanks	<p>Units that release water alongside or near to building walls need to be connected to a drain. If this is not possible then their water outlet needs to be piped several meters away from the building, as the resulting wet area is highly conducive to termites.</p> <p>Is there a need for work to be carried out?</p> <ul style="list-style-type: none"> yes - hot water unit
General recommendations	<ul style="list-style-type: none"> As this property is located in an area where subterranean timber pests are commonly found we strongly recommend that you have regular inspections carried out no later than every 6 - 12 months (or as specifically recommended above) to ensure that there is no termite activity present in your buildings and structures. Any untreated timbers in direct contact with the soil are very conducive to attack from subterranean termites. These should be removed and replaced with a material not conducive to attack such as brick, stone, concrete or treated timber. The timber off cuts/stored timbers/cardboard in the subfloor should be removed. Large trees (particularly eucalypt variety) are regular nesting sites for the most common termite species found in our region. Trees on the property have been visually inspected up to a height of 2 metres, where possible and practicable for signs of termite activity. It is however, very difficult and generally impossible to locate a termite nest visually as they are underground and evidence in trees is usually well concealed. Drilling and testing of large trees is recommended to determine if they are harbouring a termite nest. Garden beds, mulch and foliage against the structure can create conditions that are highly conducive to timber pest attack. Clearing is recommended.

It should be noted that if the risk factor specified in this report is considered to be high it is encouraging awareness that increased vigilance is warranted. Any recommendations regarding reducing conditions that are conducive to timber pests or frequency of inspections must be observed. If termite activity, active or latent, has been identified in this report, we strongly suggest an invasive inspection is carried out. To safeguard against potential timber pest attack, we recommend that a full inspection be undertaken every 6-12 months at a minimum or as specifically recommended above. We strongly encourage the property owner to consider implementing a Timber Pest Preventative Management Plan, which includes periodic Termite Inspections. A proactive approach will help ensure the ongoing protection of the property. Please call our office on 6288 0402 for advice and information or to arrange a customised schedule for this building or contact your regular inspector.

COMPLIANCE REPORT

Plan No. (if applicable)	Description	Date of COU Approvals (Certificate of Occupancy)	Comments
39256+/A	brick veneer residence	06/11/1975	
39256/B	garage & carport	31/05/1977	<ul style="list-style-type: none"> the structure has been removed
39256/D	swimming pool	28/02/1983	<ul style="list-style-type: none"> COU on folio 66 should read plan 39256/C plan /D superseded
39256/E+/F	additions	28/02/1983	
39256/G	pergola & fireplace	05/08/1985	<ul style="list-style-type: none"> no plans on file
01266/A	additions to residence & garage	06/07/2001	
B2022264/A	alterations to residence - existing roof cladding, window installations, covered alfresco & covered pergola	31/01/2022	
B20225225/A	swimming pool & fence	20/05/2024	
	carport, garden shed, retaining walls, water tank		<ul style="list-style-type: none"> the dimensions of the structure are exempt from approval, however, the garden shed and carport are located on an easement
	walls removed to bathroom/toilet area		<ul style="list-style-type: none"> approval is not required
	kitchen, bathroom, laundry renovations		<ul style="list-style-type: none"> building or development approval is not required
	kitchen window relocated		<ul style="list-style-type: none"> approval is required, structural alteration

For any incomplete approvals please email acbuildingconveynce@act.gov.au for further information on how to complete.

COMPLIANCE REPORT NOTATION

IMPORTANT NOTE - We obtained a Building File from Access Canberra to complete this Compliance Report. This report relates to Building and Development approvals only. The building file may contain floor plans, elevations, Certificates of Occupancy & Use, index, survey reports, and drainage plans. Our report is based on examining these documents and conducting a visual inspection, focusing on compliance matters from the provided file. Please be aware that if plan details are unclear or compromised, we are not liable for any omissions or errors. Refer to more details about Compliance in our Scope & Limitations. For information regarding current dimensions and approvals you can visit: planning.act.gov.au/topics/design_build/da_assessment/exempt_work

EASEMENTS - An easement is a section of land registered on your property which gives another party the right to access it for a specific purpose. An example is a section of the property that contains municipal services such as electricity, or drainage infrastructure. If a structure requires approval and is located on an easement the appropriate utility provider is consulted during the certification process and it is they who determine if an application for approval will be supported.

TCCS, PLUMBING & ELECTRICAL APPROVAL - If this report notes structures or alterations that require Transport Canberra & City Services (TCCS), Plumbing or Electrical Approval or cites plumbing and electrical additions and or alterations, please note that approval may have been granted, however, documentation is not provided in the building file. The Environment & Planning Directorate or the owner may have further information.

DEVELOPMENT APPROVAL - If this report identifies structures that require Development Approval, information relating to the status of Development Approvals will be shown on the Lease Conveyancing Enquiry provided by the solicitor. This will be included in the Conveyancing Contract for Sale. The status of a pending Development Approval is not contained within the building file we receive.

SWIMMING POOLS & SPAS - The ACT Government has introduced reforms to home swimming pool safety, with a focus on swimming pool safety barriers. The reforms commence on 1 May 2024, with a four-year transition period. The scheme imposes requirements for information about the safety standard of a regulated swimming pool to be disclosed on the sale of a property. Owners must provide prescribed information including: exemption certificate, compliance certificate, swimming pool disclosure statement, certificate of occupancy for the pool and safety barriers that is not older than 5 years and 'Pool Owners Guidance Material' which outlines the obligations on owners of premises on which a regulated swimming pool is located. If this information is not provided in this report, you must request a copy. For more information on the reforms visit the ACT Government's Planning website.

EXTENSIONS - Where an extension or addition has been made to a property, it can create a potential gap or discontinuity in the termite barrier system. This gap occurs between the original structure and the new addition. Termite barriers are critical in aiding the prevention of undetected subterranean termites from entering the dwelling, and any interruption in the barrier can compromise its effectiveness. We are unable to report on the existence, condition or continuity of the termite barrier system between the existing dwelling and additions or alterations.

Restricted access caused by stored goods, furnishings, window treatments, floor coverings, security devices, vegetation, duct work, confined spaces, insulation and other impediments will limit the scope of this inspection. Whilst every effort has been made to conduct a comprehensive roof cavity and subfloor inspection there are limitations relative to safe access requirements which include low clearances, the availability of safe walk-ways and work-safe temperatures, which when applicable, will limit the inspection. The roof exterior is inspected when accessible from a 3.6 metre ladder, or from ground level where there are height restrictions. Only structures, fences and/or trees within 30m of the building but within the property boundaries were inspected. No inspection was made, and no report is submitted with respect to inaccessible areas. These include, but may not be limited to, cavity walls, concealed frame timbers, eaves, flat roofs, fully enclosed patios, subfloors, soil concealed by concrete floors, wall linings etc. Where a property is furnished at the time of the inspection the furnishings and stored goods may be concealing evidence of Timber Pest Activity. This evidence may only be revealed when the property is vacated. A further inspection of the vacant property is strongly recommended in this case. Please note where a complete inspection of any area was not possible, timber pest activity and/or damage may exist in these areas. Prior to making any critical decisions, further inspections are strongly recommended to areas where reasonable access is unavailable, obstructed or restricted or a high risk of possible timber pests and /or damage exists.

34 Carrodus Street Fraser	
Area	Restrictions
INTERIOR	access during inspection of the interior of the property was restricted by: <ul style="list-style-type: none"> - furniture and stored goods including in cupboards and under sink units - window treatments and floor coverings - stored goods within the dwelling
SUBFLOOR	access in the subfloor was restricted by: <ul style="list-style-type: none"> - low clearances - plumbing/pipe installation - insulation
ROOF CAVITY	our inspection of the roof cavity was restricted by: <ul style="list-style-type: none"> - low clearances - insulation covering the ceiling framing - inspection around the eaves was restricted due to low pitch and clearances - sarking and duct work
ROOF EXTERIOR	roof exterior: <ul style="list-style-type: none"> - safety harness anchors and edge restraints were not available. Work Health and Safety regulations required a top of ladder inspection
GROUNDS & EXTERNAL STRUCTURES	access to the inspection of grounds/external structures was restricted by: <ul style="list-style-type: none"> - vegetation restricted visual inspection to some areas - the deck is fully enclosed and there is no access underneath the structure

WARRANTY & USE OF OUR REPORTS

This report is **intended to be read in its entirety**. The report is written solely for the use and benefit of:

The Client named in this report

The Purchaser of the property

No liability or responsibility in contract or tort or statute is accepted to any Other Party who may rely on the report wholly or in part. Any Other Party acting or relying on this report, wholly or in part, does so at their own risk. Additionally, no liability or responsibility will be accepted if the invoice for this report is not paid on or before settlement of the sale contract or within one hundred and eighty (180) days from the date of inspection.

No liability shall be accepted on account of failure of the report to notify any termite activity and/ or damage present at or prior to the date of the report in any areas of the subject property physically inaccessible, or to which access for inspection is denied by or to the Inspector including but not limited to any areas so specified by the Report. Furthermore, we do not assume liability for any omissions, errors, or inaccuracies in documents provided by external agencies, the client, or their representative. The report is only an opinion of Residential Reports and is valid for one hundred and eighty (180) days from the date of inspection as per the Civil Law (Sale of Residential Property) Act. No liability will be accepted or claims considered after the expiration of this period of liability.



Before the property exchange, you will have the opportunity to attend a pre-settlement inspection to conduct your due diligence. Carefully consider the building's age and its impact on elements like windows, doors, and cupboards. Our inspectors do not assess ongoing maintenance, and as such you or your representative should personally appraise relevant building elements. If it is claimed that there is an omission relating to this report, Residential Reports must be notified in writing before any action is taken. No liability shall be accepted where any costs (including for remedial action or professional advice) are incurred by the claimant prior to Residential Reports receiving written notification along with evidence of the defect or omission, being given a reasonable opportunity to re-inspect the property, obtain professional advice and propose a resolution or arrange for rectification work to be undertaken. Unless costs are specified and agreed to in writing, no liability will be accepted. No liability shall be accepted for any costs incurred in excess of the reasonable costs required to rectify the defect or omission claimed. ***This report supersedes any other report, verbal or written, given to you by this company in respect of this property. If you have questions or do not understand any part of this document and require clarification, please contact us prior to acting on this report. Copyright remains with Residential Reports, the report content, style and presentation is not to be copied or reproduced without written authority of the Company.***

SCOPE & LIMITATIONS OF OUR INSPECTION

This report has been prepared as a result of a largely **VISUAL INSPECTION ONLY** with limited operational testing conducted as required by Australian Standard AS 4349.0-2007 Inspection of Buildings (General requirements), AS 4349.1-2007 Inspection of Buildings (Pre-purchase inspections - Residential Buildings) and AS 4349.3 - 2010 Inspection of Buildings Part 3: Timber Pest Inspections. It is limited to the condition of those areas of the property that were fully accessible (see Safety and Reasonable Access) and visible to the inspector at the time of inspection. In the case of a Strata type property, our inspector only undertakes an examination of the interior of the unit. You must read the entire report and Scope & Limitations sections before reaching any conclusions regarding our opinion of the property's condition. Any person relying on this report acknowledges the following clauses, which define the Scope and Limitations of the inspection and form an integral part of the report.

LIMITATION OF LIABILITY

This report is valid on the date of inspection. Responsibility is not accepted for any matter that is not evident, or, for any deterioration of the property that occurs after the date of the inspection. The inspection is a visual assessment only.

The operation/working condition of limited features may have been commented on during the course of our inspection. Operational testing is limited, where testing occurs and a defect is identified, this defect may be noted in the Report if it is a major defect and may be investigated further to provide more detail. However, this does not impose on the inspector any further obligation to test each same item, nor does it impose an obligation to make note if in the inspector's reasonable view, the defect is not a major defect. There is no guarantee

that items referenced will operate as intended at a later date. Prior to purchase, the purchaser must conduct their own due diligence most particularly where defects have been documented in this report so that they are able to quantify the extent and cost of required remedial action. The Purchaser acknowledges that they should not solely rely on this Report as to the exact condition of the property and that they should obtain independent advice from a qualified technician relative to required remedial actions.

Concealed areas are not reported on. Concealed defects may include, but are not limited to:

- Breakage, blockage or interference with concealed pipes, concealed window and door mechanisms
- Defective service installations
- Any part of the structure which is underground or concealed e.g. footings, wall and ceiling framing, concealed floor structures
- Areas concealed by furnishings, fixtures and fittings or stored goods, low clearances or where safe access is not possible.

Responsibility is not accepted for defects which are latent or otherwise not reasonably detected in a visual inspection without interference with, removal or breaking apart of any of the structure including fixtures, fittings, furniture, insulation or stored items within and around the building. The inspector notes that some defects may be concealed, obstructed and/or inaccessible at the time of the inspection. The reader should be aware that various features of the property such as large and heavy furniture, as well as electrical goods including washing machines and fridges may obstruct the view of the inspector and/or make possible defects inaccessible such that their visibility to the inspector is limited and they may not be identified. The Purchaser acknowledges that Residential Reports will not accept any liability for concealed, obstructed and/or inaccessible defects that the inspector does not identify.



EXCLUSION OF ITEMS FROM INSPECTION

AS 4349.1 – 2007 excludes reporting of the following items: Footings below ground, concealed damp-proof course, electrical installations, operation of smoke detectors, light switches and fittings, TV, sound and communications and security systems, concealed plumbing, adequacy of roof drainage as installed, gas fittings and fixtures, air-conditioning, automatic garage door mechanisms, swimming pools and associated filtration and similar equipment, the operation of fireplaces and solid fuel heaters, including chimneys and flues, alarm systems, intercom systems, soft floor coverings, electrical appliances including dishwashers, incinerators, ovens, ducted vacuum systems, paint coatings, except external protective coatings, health hazards (e.g., allergies, soil toxicity, lead content, radon, presence of asbestos or urea formaldehyde), timber and metal framing sizes and adequacy, concealed tie-downs and bracing, timber pest activity, other mechanical or electrical equipment (such as gates, inclinators, soil conditions, control joints, sustainable development provisions, concealed framing-timbers or any areas concealed by wall linings/sidings, landscaping, rubbish, floor covers, furniture and accessories, stored items, insulation, environmental matters (e.g., BASIX, water tanks, BCA Environmental Provisions), energy efficiency, lighting efficiency.

WHAT THE INSPECTOR EXAMINES TO PREPARE A PROPERTY REPORT...

...AND IMPORTANT NOTES ABOUT THESE AREAS

The following outlines aspects of the property that can be examined through visual inspection, derived from the Australian Standard AS4349.1–2007. Comments are generally provided only if significant issues are found. The inspector didn't move or remove any coverings or furnishings, which could hide defects. Damage to concealed structures or pest activity may not be visible due to foliage or other obstructions. This report is a guide for potential buyers and should complement your own inspection and due diligence. Some aspects are subjective, so consider factors like presentation, past maintenance, and construction age when forming opinions.

DOORS & DOOR FRAMES - Defective hardware – significant, rotting/corroded frames, loose/badly fitting doors, damage.

EXTERNAL ROOF COVERING, FASCIAS, GUTTERS & DOWNPIPES - Tiles/slates, sheet roofing, flashing, skylights, vents, downpipes, valleys, guttering, eaves, fascia boards, barge ends. Roof waterproof integrity and roof drainage is not tested during our inspection therefore it is not possible to determine the effectiveness of the roof cover and drainage system under all conditions. It is important to note that a visual inspection of the roof covering may not identify roof leakages. Roof design can have a significant impact on roof drainage. Low pitched construction can, in adverse weather conditions lead to flooding of the roof cover. Effective roof drainage is absolutely critical for a flat framed or low pitch roof. Flooding of the roof cover can result in water ingress within the building envelope. Roof drainage and the stormwater systems are not tested at the inspection. Inadequate, blocked or non-existent stormwater drains are often accountable for problems relating to roof drainage. Repainting of timber can mask the existence of timber rot. We cannot guarantee that all timbers are sound. A visual inspection may not, in some circumstances, detect roofing timbers affected by rot.

EXTERNAL WALLS & NON-STRUCTURAL RETAINING WALLS - Bricks, mortar, render, cracking/movement, dampness, visible flashing, weep holes, joint sealants, perpend, decay. Settlement cracks, if present, need to be monitored over a period of time to determine if an ongoing structural problem exists. If any reference has been made in this report to cracking, settlement and or movement, it should be noted that we are not experts in this area and further advice, if considered necessary, should be obtained from a Structural Engineer.

FENCES & GATES - Palings/panels, rails, posts, sagging, timber decay (rot).

FLOORS - **TIMBER**: Springy or squeaky boards/sheeting, timber decay (rot), out of level – significant, undulations - significant, dampness/water damage; **CONCRETE**: cracking, out of level – significant; **HARD FLOORING**: cracking, loose or drummy units, dampness/water damage

INTERNAL ROOF SPACE - Framing, insulation, sarking, party walls (if applicable). Sarking is a foil insulation/vapour barrier. Used in conjunction with bulk insulation, sarking provides an ideal insulation system for the control of heat and condensation. Sarking can only be installed during construction.

KITCHEN - Fit out, sealants, ventilation, taps, leakage, sink, drummy/cracked/missing tiles, grout defects. This report does not cover any matters relating to the operation of electrical or gas appliances. Any comments made in this regard are from a general observation only.

PAINTWORK - The condition of painted surfaces is often a subjective matter. Areas that appear to be acceptable when furnished may not always be considered so when devoid of obstructions. Paint work is normally not considered in Property Inspections. To prevent wood decay of timber surfaces and deterioration of metal components, the condition of these surfaces should be monitored, and repainting carried out regularly. Corrosion of any metal roof sheeting should be repaired, treated and painted to avoid water leakages. Painted surfaces can mask areas where timber has deteriorated. Our visual inspection may not detect instances where this has occurred. The opinions provided here are of a general nature only, given that there can be significant differences in the condition of painted surfaces in each area of the property. The reader of this report is urged to conduct their own detailed inspection before reaching a conclusion regarding the acceptability of painted surfaces

PATHS, PAVING & DRIVEWAY - Cracking, movement, uplifting, sinking, alignment, roof penetration.

SPECIAL PURPOSE REPORTS - Improvements such as swimming pools and spas are subject to a Special Purpose Report and are not included in our inspection and reports. We recommend that a qualified technician be engaged to report on these items and to advise on current regulations relating to safety fencing and equipment.

STAIRCASES - Stringers, handrails, balustrades, newel posts, treads (goings), risers

SUB FLOOR - Dampness, debris, drainage, ventilation, cracked or leaking pipes; **TIMBER CONSTRUCTION**: bearers & joists, framing, piers/stumps; **SUSPENDED CONCRETE FLOOR CONSTRUCTION**: concrete condition, cracking. If moisture is noted, it is recommended that the sub-floor area be monitored to ensure that surface and sub-surface moisture ingress is not an ongoing issue. If the area remains damp, consideration should be given to upgrading subterranean and surface drainage systems to ensure that moisture is directed away from the building foundations and the sub-floor area is kept dry. A qualified drainage expert should be consulted with regard to drainage issues.

Foundation problems are caused by reactive soil types and trees and gardens being planted too close to the building. Generally, clay soils which are common in the ACT, are reactive soils. Large trees use vast amounts of water and can quickly draw moisture out of the ground during dry periods, this results in destabilised moisture content of the soils around the building and ultimately may cause a foundation problem. Over watering gardens close to the building may have the opposite effect, especially with clay soil. Over watering increases the moisture content of the soil which can result in “heaving” of the foundations adjacent to the garden. When watering close to the building you should avoid ‘pooling’ of water in a particular area, as this also affects the moisture content of the soil which in turn can cause damage to footings and foundations. Too much or too little water near the perimeter of the building may cause serious problems with foundations and footings and damage can cause major structural problems, resulting in costly repairs.

HINTS FOR AVOIDING PROBLEMS AND COSTLY REPAIRS:

- Water gardens evenly close to the building and do not over water
- Ensure the ground is graded away from the walls of the building and that the property has adequate drainage
- Promptly repair broken downpipes, leaking taps, sewerage pipes and other water services
- Hot water system overflows should be directed away from the area immediately adjacent to the foundations and the services maintained to ensure excessive leakage does not occur
- Garden beds should not be located against the house

TIMBER PESTS - Our visual inspection is undertaken to identify the following timber pests: Subterranean termites, Borers, Timber decay (rot) fungi. Where applicable and where there is reasonable access, the following areas are examined: interior and exterior of structures, roof cavity, subfloor, garage or carport, garden and storage sheds/outbuildings, retaining walls and garden borders, pergolas and decks, structures, fences and trees within 30m of the building within the boundaries of the property. Water leaks: especially in the subfloor or against external walls e.g. leaking taps, roofs or down pipes, increases the likelihood of termite attack. Leaking showers or leaks from other 'wet areas' also increase the likelihood of concealed timber pest attack. Where evidence of termite activity was found in the grounds then the risk to buildings is very high. A treatment to eradicate the termites and to protect the building(s) should be immediately carried out. Where the evidence of termite workings (including dormant mud leads) was found in the grounds or the building(s) then the risk of a further attack is very high. If live termites or any evidence of termite workings or damage was reported within the building(s) or in the grounds and fences then it must be assumed that there may be concealed termite activity and/or timber damage. This concealed activity or damage may only be found when alterations are carried out such as when wall linings, cladding or insulation are removed or if you arrange for an invasive inspection. In situations where visual evidence of termite activity or damage is reported, but no live termites were observed during the inspection, it's important to recognise that termites might still be active in the immediate vicinity, potentially causing further damage. Determining whether the infestation is active or inactive requires multiple inspections over time, as various factors, such as prior disturbances, climatic conditions, or the termites finding an alternative food source, can influence their presence during a single inspection. To safeguard against potential termite-related issues, we recommend continued, regular inspections. **An invasive inspection is also an option for a more comprehensive assessment. We strongly encourage the property owner to consider implementing a Timber Pest Preventative Management Plan, which includes periodic Termite Inspections. This proactive approach will help ensure the ongoing protection of the property against potential termite threats. Please call our office on 6288 0402 for information and to arrange a customised schedule for this building or contact your regular inspector.**

WALL CONSTRUCTION - Distortion (significant), nail popping, defective lining, dampness/water damage, cracking, defective or damaged plaster/render. Settlement cracks, if present, need to be monitored over a period of time to determine if an ongoing structural problem exists. If any reference has been made in this report to cracking, settlement and/or movement, it should be noted that we are not experts in this area and further advice should be obtained from a Structural Engineer.

WATERPROOFING - A VISUAL INSPECTION OF THE AREA CANNOT PROVIDE CONCLUSIVE EVIDENCE THAT THE AREA IS WATERPROOF. Compliance with Australian Standard AS 370-2004 Waterproofing of Wet Areas is critical to meeting waterproofing requirements. Should conclusive evidence be required regarding the integrity of waterproofing of wet areas, in particular shower areas, we recommend that a qualified technician be engaged to complete a comprehensive test to include:

- Capping the shower rose and leaving the water reticulation system under pressure and then checking for evidence of water leakage around tap spindles etc. (the sound of escaping air when the shower rose cap is removed indicates a watertight system). The technician may be engaged to complete a comprehensive pressure test of the entire water reticulation system.
- Plugging the floor drain of the shower cubicle and filling the base with water to the maximum level. Allowing the water to remain in the base for an extended period and checking that the level has not dropped. If the water has diminished it is most likely that the waterproofing system has failed.

WET AREAS - Fixtures and fittings, ventilation, cistern/pan, taps, basins, tubs, leakage, sealants, drummy/cracked/missing tiles, grout defects, vanity, shower leakage, broken/cracked glass. If a wet area was not in service prior to and or at the time of inspection and no elevated moisture readings were recorded, or there was no visible evidence of current water leakage, then it is possible that an existing water leak will remain undetected.

WINDOWS - Putty/glazing sealant, broken glass, rotting frames (timber), corrosion (metal), sills, fittings/hardware, damage. In most cases access to windows is restricted by window treatments, furniture or security locks. Older style timber windows can sometimes bind with the frame. This is viewed as a general maintenance issue. Sash windows sometimes require maintenance to the window balance mechanism or sash cords. A visual inspection cannot provide a guarantee that windows will operate smoothly. Sometimes window runners, sashes and balance mechanisms will require maintenance or replacement.



SAFETY & REASONABLE ACCESS

Australian Standard 4349.1 – 2007 3.2.2 The extent of accessible areas shall be determined by the inspector at the time of inspection, based on the conditions encountered at the time of inspection. The inspector shall also determine whether sufficient space is available to allow safe access. The inspection shall include only accessible areas and areas that are within the inspector’s line of sight and close enough to enable reasonable appraisal. The Australian Standard 4349.3 defines reasonable access as “areas where safe, unobstructed access is provided and the minimum clearances are available; or, where these clearances are not available, areas within the consultant’s unobstructed line of sight and within arm’s length. NOTE: Reasonable access does not include removing screws and bolts to access covers.” Reasonable access is determined in accordance with the provisions of the following WHS requirements;

Area	Access Manhole MM	Crawl Space MM	Height
Subfloor	500 x 400	VERTICAL CLEARANCE - Timber Floor: 400* Concrete Floor: 500	Height
Roof Interior	400 x 500	600 x 600	Accessible from a 3.6 m ladder
Roof Exterior			Accessible from a 3.6 m ladder

* To underside of bearer, joist or other obstruction to access.

ROOF COVER INSPECTION

Work Health and Safety requirements determine that an inspector accessing a roof cover must be protected by harnessed safety lines and or edge protection. These safety measures are not practical during a presale inspection, therefore, this report is restricted to a “top-of-ladder” inspection. This report is not a guarantee that defects and/or damage do not exist in any part of the property not specifically seen and described by the inspector. This report is not a warranty against problems that may develop in the future.

CEILING CAVITY INSPECTION

Work Health and Safety requirements determine that an inspector entering a ceiling cavity or similar space must have direct access to properly constructed walkways (sometimes referred to as catwalks) to eliminate the possibility of falling through the ceiling lining to the floor below, a fall that could result in serious injury. Generally, walkways are limited in a ceiling cavity so invariably sections of the roof structure will be inspected from a distance with the inherent limitations associated with limited access and often an impaired line-of-sight. Safety requirements prevent the inspector from traversing a ceiling cavity where safety elements are not available This report is not a guarantee that defects and/or damage do not exist in inaccessible areas.

WORK HEALTH & SAFETY ACT 2011

A non-residential building and the common property of some group residential buildings will fall within the definition of a workplace for the purposes of the Work Health and Safety Act 2011, The owners of workplaces must ensure that:

- Premises are safe and without risk
- Plant and substances are used without risk
- Workers are trained in WHS, are aware of their obligations and do, in fact, act in a safe manner

A pre-purchase building inspection may identify some safety issues in the common area but it is not an audit conducted for that specific purpose. It is essential that every Owners’ Corporation or Company consult an appropriately qualified specialist to ensure it meets its legislative obligations.

SAFE WORKING TEMPERATURES FOR THE INSPECTOR

When the temperature of a workspace (for example a ceiling cavity) exceeds the level considered to be safe according to WHS guidelines, the inspector will complete a risk assessment and the inspection will be limited accordingly. In the event that the inspector determines that the temperature exceeds safe working limits, generally, the inspection will be limited to the area immediately adjacent to the access for inspection.

PROPERTY REPORT

This report does not and cannot make comment upon: defects which may have been concealed; the assessment or detection of defects (including rising damp or leaks) which may be subject to the prevailing weather conditions; whether or not services have been used for some time prior to the inspection and whether this will affect the detection of leaks or other defects; the presence or absence of timber pests; gas fittings; environmental concerns; the proximity of the property to flight paths, railways, or busy traffic; noise levels; health and safety issues; heritage concerns; security concerns, fire protection; site drainage (apart from surface water drainage). The operation of swimming pools and spas; detection and identification of unapproved building work; detection and identification of illegal or inadequate plumbing or electrical work: durability of exposed finishes; neighbourhood problems; document analysis; any matters solely regulated by statute; any area or item that could not be inspected by the inspector. Unless otherwise specified, no examination has been made of any documentation of any type. We have not referred to statutory authority records nor have we examined any survey or water and sewerage service diagram, or any other document prepared by any statutory authority or other party. Stock images in the report are for presentation purposes only and are not images of the subject property.

PURPOSE OF THE REPORT - The purpose of this report is to identify major defects in the building, decks, pergolas, garages and other similar significant improvements insofar as a property inspector can reasonably identify those defects. Structures, not limited to but including, garden sheds, play equipment, garden trellis, swimming pools and spas are not inspected or included in this report. A Special Purpose Report may be commissioned for these types of improvements. This report contains numerous observations but is not intended to list every defect. Defects are common to all structures and generally are commensurate with the age of the construction and use. Ongoing maintenance, upgrading or replacement requirements, cosmetic works and minor defects or faults are subjective and have not been included.

CONCEALED SURFACES - The inspection did not include breaking apart, dismantling, removing or moving objects, including but not limited to foliage, mouldings, roof insulation or sisalation, floor or wall coverings, sidings, ceilings, floors, furnishings, equipment, appliances, or personal possessions. The inspector cannot see inside walls, between floors, inside skillion roofing, behind stored goods or any other areas that are concealed or obstructed. The inspector did not dig, gouge, force or perform any other invasive procedures. Visible timbers have not been destructively probed or hit. In an occupied property, furnishings or household items may be concealing defects. Some defects may only be visible once furniture and other items have been removed from a property or when alterations are carried out. Built-in cupboards are usually filled with personal items and clothing. Some exterior surfaces may be obscured due to overgrown vegetation. Therefore, we cannot comment on the condition of the surfaces obscured or concealed by these or other items.

WATER PENETRATION & ROOF DRAINAGE - Some water penetration problems and/or dampness within a building do not become apparent and may not be detected unless there has been recent heavy rain or prolonged periods of rain. If moisture has been identified by the inspector using electronic testing equipment, then it will be noted in the report. Roof drainage is not tested. Therefore, no guarantee is given or implied that the roof will remain weatherproof in all weather conditions. If there is reference in the report to water stains within the interior of the property this may be evidence that the roof and or drainage system has previously leaked. We recommend that you contact a suitably qualified roofing expert to discuss the probability of ongoing water leakages in the building. Particularly with respect to older properties and where the roof has a low pitch, engaging the services of qualified roof plumber to provide an expert opinion should be considered. The very best roof drainage systems can fail in extreme weather conditions sometimes impacted by conditions not related to the property under review. (Blocked or impaired stormwater drains for example).

FIRE PROTECTION EQUIPMENT & ORDINANCE REQUIREMENTS - These are not covered by this report and these matters should be checked with the statutory authority. Any fire protection equipment has not been tested, e.g. smoke detectors etc.

HAZARDOUS MATERIALS & CONTAMINATION - Our inspection and report does not cover any hazardous materials or prior use of the land and building or any chemicals applied to land and buildings, which may have caused contamination.

RETAINING WALLS & STRUCTURAL COLUMNS - We are not engineers. Comment in respect of large and/or structural retaining walls and columns are beyond the scope of this report. It is not possible to determine from a visual inspection whether a retaining wall or column has been built in accordance with sound engineering principles and, even if it has, whether it is or will remain sound. An engineer should be consulted in any case where there are large, or structural, retaining walls, columns or similar building elements.

INTERNAL WALLS & CEILINGS - Movement cracking in ceiling and wall linings are common to most structures particularly older developments. Mostly they are cosmetic and generally have no structural implications. Repairation is usually undertaken during routine maintenance. Undulations in ceiling linings are often associated with older structures and are a result of the deterioration of the adhesive used to fix plasterboard to the ceiling battens. Typically, this is a cosmetic defect, however, in some circumstances the plasterboard may require refixing to the battens.

CRACKING/SETTLEMENT/MOVEMENT & STRUCTURAL INTEGRITY - Where reference has been made in this report to cracking, settlement, movement or an opinion has been provided on structural integrity, it is important to note that we are not experts in this area and our advice is limited accordingly. If considered necessary, further advice should be obtained from a Structural Engineer before critical decisions are made. Any cracking reported should be monitored for further movement. If further movement is noted, a Structural Engineer should be consulted at the earliest opportunity. Cracking of masonry walls is very common in the ACT, particularly where there are volatile clay soils. There may be some superficial or hairline cracks that we consider have no structural implications which have not been identified.

ELECTRICAL, GAS & OTHER SERVICE INSTALLATIONS - We are not licensed electricians, gas fitters or mechanical engineers. This report does not cover any matters relating to electrical and gas installations or any apparatus operated by electronic, mechanical or hydraulic means. This report does not cover any matters relating to the operation of electrical or gas appliances. Any comments made in this regard are from a general observation only. You should satisfy yourself as to the operation and condition of any appliances or other installations. Any comments made in this regard are from general observation only. There has been no electrical, data, security or fire detection system testing or investigation.

PLUMBING & DRAINAGE - We are not licensed plumbers and a specialist inspection of the water service, plumbing and drainage system including roof drainage is excluded from this report. We recommend an inspection by a licensed plumber and drainer to identify any plumbing faults or drainage problems.

TIMBER PESTS - If this report does not include one, we strongly recommend that an independent inspection and report be obtained from an accredited Pest Inspector to determine whether the property is free from infestation (whether active or dormant).

BOUNDARIES - Unless otherwise stated, the inspector has not gained access to any neighbouring properties and is therefore unable to comment upon the external state of any boundary fences and walls. The common areas of unit developments are not inspected. Any comments made in relation to common areas are strictly observational.

RURAL PROPERTY INSPECTION - This inspection and report relates to the residential structure; rural improvements on the property are not inspected or reported on, any comments contained in this report relative to rural improvements are strictly observational.

AREAS AND DIMENSIONS - Whilst every care has been taken to accurately quantify dimensions referenced in this report, we accept no responsibility for inaccuracies as supplying this information exceeds the requirements of a standard building inspection as per Australian Standard 4349.1-2007. In many instances scale plans are not available and therefore the reader should not rely on this report when making critical decisions relating to dimensions.

ELEVATED STRUCTURES - Where reference has been made in this report to an elevated structure such as a deck balcony or veranda, it is important to note that we are not Structural Engineers and accordingly our advice is limited. Any opinion relating to structural integrity is relative to weight loadings typical of a normal household event. Prior to loading the structure beyond normal, which may occur at a larger gathering, we recommend that professional advice be obtained to determine that the structure will safely cope with the weight loading. Additionally, the structure should be regularly inspected to ensure that structural integrity is maintained.

SPECIAL PURPOSE REPORTS - This Property Report does not contain any assessment or opinion in relation to any item which is the subject of a Special Purpose Property Report, or any matter where the inspection or assessment of which is solely regulated by Statute. Special Purpose Property Reports include comment on the following: common property areas, environmental concerns such as sunlight, privacy, streetscape and views, proximity of property to flight paths, railways and busy traffic or other neighbourhood issues; noise levels; WHS issues including, but not limited to the presence of asbestos, lead or other hazardous materials; heritage concerns; security or fire protection systems; climate control or water heating systems; analysis of site drainage apart from surface water drainage; swimming pools and spas; detection and identification of illegal and unauthorised plumbing work; durability of exposed finishes.

COMPLIANCE REPORT

The information within this report relies on the plans, survey reports, certificates of occupancy and other relevant documents supplied by the Environment & Planning Directorate (EPD), the appropriate local council or Directorate, the client or their agent. Our company or its employees are not responsible for any omissions or errors where incomplete, inaccurate or illegible information is supplied. It is the responsibility of the property owner to resolve any file discrepancies with the relevant authority. Documentation of any plumbing or electrical alterations is not included in the building file. If required, this documentation can be obtained by the title holder from the relevant utilities provider. If the subject property features a second driveway or verge crossing, Transport Canberra & City Services approval may be required. This information is not supplied in the building conveyancing file. If this report confirms that certification is 'pending' for an unapproved structure, it is important that you are aware that this process can take weeks and involve more than one agency including but not limited to the Environment & Planning Directorate, Icon & Transport Canberra & City Services. Whilst it is rare, in some instances throughout the approvals process an application may be rejected. The Compliance Report relies on documentation provided in the Building File. Residential Reports Inspectors are not Building Surveyors. Certifications included in the file are not cross referenced with the Building Code of Australia (BCA) applicable at the time of construction to confirm that the improvements are compliant with the BCA. This is the responsibility of the Building Surveyor prior to issuing a Certificate of Occupancy. No attempt is made in this inspection and reporting process to confirm that the existing improvements on the subject property are in strict accordance with approved plans. There may be variations in design, features and dimensions that conflict with each other. Additionally, there is no guarantee given that improvements are in accordance with the current Building Code of Australia. In most circumstances, there is no requirement to upgrade specifications to the current Building Code.

SWIMMING POOLS & SPAS - The ACT Government has introduced reforms to home swimming pool safety, with a focus on swimming pool safety barriers. The reforms commence on 1 May 2024, with a four-year transition period. The scheme imposes requirements for information about the safety standard of a regulated swimming pool to be disclosed on the sale of a property. Owners must provide prescribed information including: exemption certificate, compliance certificate, swimming pool disclosure statement, certificate of occupancy for the pool and safety barriers that is not older than 5 years and 'Pool Owners Guidance Material' which outlines the obligations on owners of premises on which a regulated swimming pool is located. If this information is not provided in this report, you must request a copy. For more information on the reforms visit the ACT Government's Planning website.

TIMBER PEST REPORT

This report is the result of a VISUAL INSPECTION ONLY. Inspection of the property and this report has been completed with reference to AUSTRALIAN STANDARD AS 4349.3 - 2010 Inspection of buildings Part 3: Timber Pest Inspections. In all instances throughout this report the inspector is referring to accessible areas only. Areas that were not accessible at the time of inspection or were concealed from view are not covered by this report. The inspector does not imply that inaccessible or partly inaccessible areas of the property were not, or have not been, infested by Timber Pests. This Report is not a guarantee that an infestation or future infestation and/or damage does not exist in any inaccessible or partly inaccessible areas of the property. This inspection DID NOT include breaking, removing or moving objects, floor and wall coverings, roof insulation, foliage, furniture, appliances stored goods and personal possessions - these all limit the scope of inspection. The inspector does not have access to the inside of walls, between flooring, inside eaves and skillion roofing. This Report is confined to reporting infestation and/or damage caused by white ants (subterranean and damp wood termites), borers of seasoned timber and timber pests (wood decay fungi), present on the date of the Inspection. The Inspection did not cover any other pests and this Report does not comment on them. Dry wood termites and European House Borer (*Hylotrupes bujulus* Linnaeus) are excluded from the inspection due to the extreme difficulty in locating the small colonies. Some species of termite and house borers, if discovered, will be reported (by law) to Government Authorities.

TERMITE RECOMMENDATIONS - Where evidence of termite activity or workings was found in any structure then the risk to buildings is very high and the risk of further attack is also high. A treatment to eradicate the termites and to protect the building(s) should be carried out. If live termites or any evidence of termite workings or damage was reported within the building(s) or in the ground and fences then it must be assumed that there may be concealed termite activity and/or timber damage. This concealed activity or damage may only be found when alterations are carried out such as when wall linings, cladding or insulation are removed or if you arrange for an invasive inspection. We claim no expertise in engineering or building. We strongly recommend that you have a qualified person such as a Builder, Engineer, Architect or other qualified expert in the building trade determine the full extent of the damage, if any. This may require an invasive inspection. We take no responsibility for the repair of any damage whether disclosed by this report or not.



Where visual evidence of termite workings and/or damage is reported but no live termites were present at the time of inspection, you must realise that it is possible that termites are still active in the immediate vicinity and the termites may continue to cause further damage. It is not possible, without benefit of further investigation and a number of inspections over a period of time, to ascertain whether any infestation is active or inactive. Active termites may simply have not been present at the time of inspection due to a prior disturbance, climatic conditions, or they may have been utilising an alternative feeding source. Continued, regular, inspections are essential. Unless written evidence of a termite protection program in accord with "Australian Standard 3660" with ongoing inspections is provided, you must arrange for a treatment in accord with the standard to be carried out immediately to reduce the risk of further attack.

Where the evidence of live termite or termite damage or termite workings (mudding) was found in the building (s) then the risk of a further attack is very high. Where evidence of live termites or termite damage or termite workings was found in the grounds but not in the buildings then the risk to buildings is very high.

If evidence of drill holes in concrete or brickwork or other signs of a possible previous treatment is reported then the treatment was most likely carried out because of an active termite attack. Extensive structural damage may exist in concealed areas. You should have an invasive inspection carried out and have a builder determine the full extent of any damage and the estimated cost of repairs as the damage may only be found when wall linings etc are removed. Normally if a termite treatment has been carried out then a durable notice should be located in the meter box indicating the type of termite shield system, treated zone or combination has been installed.

BORER RECOMMENDATIONS - Borer activity is usually determined by the presence of exit holes and/or frass. Since a delay exists between the time of initial infestation and the appearance of these signs, it is possible that some borer activity may exist that is not discernible at the time of inspection. If borers are identified replacement of all susceptible timbers is always preferred since, in the event of selling the property in the future it is probable that an inspector will report the borers as active. A chemical treatment to control and/or protect against Furniture beetle and/or Queensland pine beetle can be considered as a less effective, lower cost option. Before considering this option You should consult with a builder to determine if the timbers are structurally sound. Following the initial treatment, a further inspection is essential in twelve months' time to determine if further treatment is needed. Treatments over a number of consecutive years may be required. The *Lyctus brunneus* (powder post beetle) is not considered a significant pest of timber. Damage is confined to the sapwood so treatment or timber replacement is not usually required. However, you should have a building expert investigate if any timber replacement is required. *Anobium punctatum* (furniture beetle) and *Calymnaderus incisus* (Queensland pine beetle) must always be considered active, unless proof of treatment is provided, because, unless the timber is ground up, one cannot determine conclusively if activity has ceased. Total timber replacement of all susceptible timbers is recommended. A secondary choice is treatment. However, the evidence and damage will remain, and the treatment may need to be carried out each year for up to three years.

HIGH MOISTURE READINGS, DRAINAGE & VENTILATION - High moisture readings can be caused by any one of the following: poor ventilation, ineffective drainage, leaking pipes, leaking roofs, defective flashing or by concealed termite activity. The areas of high moisture should be investigated by way of an invasive inspection. High moisture levels also increase the likelihood of termite attack and may also be conducive to borer activity and wood decay. If high moisture was reported then you must have a building expert investigate the moisture and its cause and determine the full extent of damage and the estimated cost of repairs.

If drainage is considered inadequate, a plumber or other building expert should be consulted, and remedial measures should be taken. Ventilation of the sub-floor region is important in minimising the opportunity for subterranean termites to establish themselves. Consideration should be given to installing high air flow vents and/or improve the cross flow of air within the subfloor to produce ventilation equivalent to 8400 sq mm net ventilation area per lineal metre on external and internal walls.

INFILL AND CONCRETE SLABS - Any building or part of a building that is constructed on a concrete slab is always more susceptible to termite attack because of possible concealed termite entry. A very high proportion of termite attacks are over the edge of both infill and other concrete slab types. If the edge of the slab is concealed by concrete paths, patios, pavers, garden beds, lawns, foliage, etc then it is possible for termites to conceal their entry into the property. Termites can then cause extensive damage to concealed framing timbers. Even the most experienced inspector may be unable to detect their presence due to concealment by wall linings. Only when the termites attack timbers in the roof void, which may in turn be concealed by insulation, can their presence be detected. Infill slab type construction has an even higher risk of concealed termite ingress as the slab edge is concealed due to the construction design and is not exposed. The type of slab may only be determined by assessment of the construction plans by a qualified person such as a Builder, Certifier or Architect. Construction Plans may be obtainable by your conveyancer. Termite activity and or damage may be present in concealed timbers of the building. We strongly recommend frequent regular inspections

in accordance with AS 3660.2. Where the slab edge is not fully exposed, or the slab is an infill slab or the slab type cannot be determined then we strongly recommend inspections every 3 to 6 months in accordance with AS 3660.2. Infill slab: A slab on the ground cast between walls. Other slabs should be in accordance with AS 2870 - 1996 and AS 3660.1-2000.

TIMBER (FUNGAL) DECAY - We claim no expertise in building and if any evidence of fungal decay or damage is reported you should consult a building expert to determine the full extent of damage and the estimated cost of repairs or timber replacement.

DETERMINING EXTENT OF DAMAGE - This Report is NOT a structural damage report. You agree that we are not responsible or liable for the repair of any damage, whether disclosed by our report or not. Our inspectors are not necessarily specialised builders and any inexperienced opinion provided with respect to timber damage cannot be relied upon. The Report will not state the full extent of any timber pest damage; rather, we may provide comment on the damage for your information. If evidence of Timber Pest activity and/or damage is reported in the structure(s) or the grounds of the property, then you must assume that there may be further concealed structural damage within the building(s). This concealed damage may only be found when invasive procedures are applied to reveal previously concealed timbers. In the case of Timber Pest activity and/or damage WE STRONGLY RECOMMEND an invasive Timber Pest Inspection is undertaken and a qualified person such as a Builder, Structural Engineer, or Architect be engaged to carry out a structural inspection to determine the full extent of the damage and repairs that may be required.

MOULD - Mould (also referred to as Mildew and non-wood decay fungi) is not considered a Timber Pest. This report does not extensively cover the inspection of Mould. If evidence of mould was observed during the inspection, it may be noted for your information. If you are concerned as to the possible health risk resulting from the presence of mould, then you should seek advice from your local State or Commonwealth Government Health Department expert.

IMPORTANT INFORMATION

This Report reflects the condition of the property existing at the time of the inspection date and may not reflect the current state. Timber Pests, particularly termites, may have gained entry to the property since the inspection date. Termites can, in a relatively short period, cause significant damage to both structural and non-structural timbers within and around the buildings of the property. Termites are difficult to detect and much of the damage caused may not be readily visible, if damage exists, it may be costly to repair. If the Report indicated the presence of termites, termite damage, previous activity or treatments, or recommends a treatment, you should obtain copies of the treatment proposal, any certificates of treatments carried out, details of all repairs including copies of quotations, invoices and any other reports. It is strongly recommended that you arrange for an inspection in accordance with AS 4349.3 to verify that the treatment has been successful and carried out in accordance with AS 3660.2 and arrange for a further building inspection in accordance with AS 4349.1. The person carrying out the inspection and this company will have no liability to you for any damage or loss you may suffer as a result of your entering the contract to purchase the property or in connection with completing the purchase of the property as a result of your failure to heed the advice given in this report and may use such failure in defence of any claim that you may later make against any of them.

Where a property is furnished at the time of inspection, you will appreciate that the furnishings, floor coverings and stored goods may be concealing any evidence of Timber Pest Activity which may only be revealed when the items are moved. Where fences are obscured by foliage, overgrowth or structures, evidence of timber pest activity or damage may be concealed. Poor subfloor drainage increases the likelihood of termite attack. If the risk factor stated in this report is high, this is the opinion of the inspector and should encourage awareness that increased vigilance is warranted and that recommendations for the reduction of unfavourable conditions that increase the chances of termite activity must be strictly observed. It is strongly recommended that a comprehensive timber pest inspection by a qualified timber pest inspector is undertaken every 6-12 months (or more frequently if specified in the report). Regular inspections DO NOT prevent timber pest attack. Regular inspections increase the chance of the early detection of timber pest activity thereby limiting the structural damage that may occur. The overall degree of risk of Timber Pest Infestation cited in this report is a subjective assessment by the inspector at the time of the inspection, taking into account many factors which include, but are not limited to, location and proximity to bushland and trees and/or other timber structures, evidence of timber pest damage or activity close to the inspected structure or within the inspected structure, conducive conditions that raise the potential of timber pest attack, such as timbers in contact with soil, inaccessible areas, slab on ground construction, or other factors that, in the inspector's opinion, raise the risk of future timber pest attack.

A more thorough INVASIVE INSPECTION is available. Where any current visible evidence of Timber Pest activity is found it is strongly recommended that a more invasive inspection is performed. Trees and stumps on the property with a diameter in excess of 100mm have been visually inspected for evidence of termite activity to a height of 2m where access was possible and practical. It is very difficult, and generally impossible to locate termite nests since they are underground and evidence in trees is usually well concealed. We therefore strongly recommend that you arrange to have trees test drilled for evidence of termite nests.

RESOURCE LIBRARY

Where reference is made to the Residential Reports Resource library, [you may access this content by clicking here.](#)

QUICK FACTS

- Sellers of residential properties are required to provide an Energy Efficiency Rating (EER) to potential buyers. (This is known as mandatory energy efficiency disclosure.)
- The EER forms part of the Sale Contract and must be published in all advertising material.
- The EER rating system uses computer simulations to assess the potential thermal comfort of your home.
- The more stars, the less likely the occupants need cooling or heating to stay comfortable.
- The ACT Government has two systems in place for Energy Ratings:

One is for established homes
(1st Generation Software)

One is for new homes
(2nd Generation Software)

Residential Reports (and all other companies preparing reports for the sale of a property on an existing Canberra home that has been previously occupied) are required to use 1st Generation Software.

- The consumption of energy in the home for heating, cooling, hot water or lighting and other appliances IS NOT considered in the application of 1st generation software when calculating the EER rating.
- Many aspects of solar passive designs are also not able to be accounted for in 1st Generation Software.

WHAT IS RATED?

The rating is dependent on:

- Layout of the home
- Construction of its roof, walls, windows and floor
- Wall, floor and ceiling insulations
- Orientation of windows and shading of the sun's path and local breezes
- Influence of the local climate

WHY IS THERE A DISCREPANCY BETWEEN MY OLD EER AND MY NEW EER?

- Increasingly, in a number of circumstances particularly where new homes have been rated using 2nd generation software and are now being offered for sale where the rating must be conducted using 1st generation software, there can be a significant variation between the two ratings:

1st generation software rates to 6 stars

2nd generation software may rate up to 10 stars

- ACT Legislation currently PROHIBITS Inspectors from assuming insulation values which may have been the case previously. Documented proof or visual sighting is now required to verify the existence and rating of insulation.

Your Energy Rating is calculated using software approved by the ACT Government.

Pool Owner Guidance Material

The ACT Government is committed to avoiding preventable deaths and serious injuries from fatal and non-fatal drownings in home swimming pools and spas in the ACT.

New rules aim to protect the public by making sure that home swimming pools and spas in the ACT have a safety barrier that is compliant with modern safety standards and that they are maintained.

This document outlines the obligations for people who own a property with a *regulated swimming pool* for the period 1 May 2024 to 30 April 2028.

Regulated swimming pools

The new rules apply to regulated swimming pools, which are home swimming pools or spas that are:

- capable of containing water to a depth greater than 30cm; and
- associated with a residential building such as a house, unit, townhouse or block of apartments.

This includes in-ground and above-ground pools, temporary and permanent pools, wading pools, demountable pools, portable pools, kids' pools and spas.

If your inflatable pool can be deflated and inflated and does not have a filtration system you are not covered by the scheme. If any part of the pool requires assembly other than inflation (i.e. has a frame), or if the pool uses or comes with a filtration system, it is a demountable pool and therefore covered by the scheme.

Scheme commencement and transition period

The scheme commences on 1 May 2024, with a four-year transition period for homeowners to have a compliant safety barrier for their regulated swimming pool or obtain an exemption.

Compliant safety barrier

From 1 May 2028, it will be an offence to have a regulated swimming pool that does not have a safety barrier which meets the prescribed safety standards unless an exemption applies.

For pools built, altered or installed before 1 May 2023, the safety standards are:

- the current version of the Building Code of Australia (NCC 2022); and
- two Australian Standards which are Part 1 and Part 2 of Australian Standards for Swimming pool safety.
 - Part 1 (AS 1926.1 – 2012) relates to safety barriers for swimming pools
 - Part 2 (AS 1926.2 – 2007) is about the location of safety barriers

The Building Code and these two Australian Standards are the current safety standards which stop young people accessing pools and lessen the risk of drowning.

The changes that need to be made to swimming pool and spa safety barriers to make them compliant with the prescribed safety standards will depend on the type of safety barrier that is currently in place and the location of the swimming pool or spa in relation to other buildings, structures and boundary fences on the property. Information about what changes you may need to make can be found in the factsheets on the [Home Swimming Pool Safety Reforms](#) webpage on the ACT Government planning website.

Pools built, altered or installed on or after 1 May 2023 must meet:

- the Building Code of Australia as adopted in the ACT at the time the swimming pool or spa is built or altered; and
- the Australian Standards called up by the Building Code at the time the swimming pool or spa is built or altered.

Exemptions

Under the scheme, there are some circumstances where a pool is not required to comply with the prescribed safety standards and the owner of the premises does not need to apply for an exemption.

Date of pool construction	Before 1 May 2023	On or after 1 May 2023
A demountable pool that will not be in place for more than three consecutive days	Yes	Yes
A spa which is covered and secured by a lockable child-resistant structure (such as a door, lid, grille or mesh) that meets the prescribed requirements	Yes	A lockable child-resistant structure will be permitted if it satisfies the prescribed safety standard
A spa that is located on the balcony of an apartment where self-closing and self-latching doors and/or windows restricts access	Yes	A spa located on a balcony must comply with the prescribed safety standard

There are also circumstances where homeowners or owners corporations can apply for an exemption from compliance if the pool is unable to have a safety barrier compliant with the prescribed safety standards.

Date of pool construction	Before 1 May 2013	Between 1 May 2013 and 30 April 2023	On or after 1 May 2023
A swimming pool area is unable to physically accommodate a safety barrier compliant with the prescribed safety standard	Yes	No	No
Compliance with the prescribed safety standard would be reasonably likely to require approval to remove a protected tree	Yes	No	No
Compliance would have a significant adverse effect on the heritage significance of a place or object registered under the <i>Heritage Act 2005</i>	Yes	No	No
Compliance would prevent a person with a disability from accessing the swimming pool	Yes	Yes	No
Documented plans to remove and not replace the swimming pool within 24 months	Yes	Yes	No

Offences and penalties apply for failing to notify of a change of circumstances that affects a ground on which an exemption was granted, and for failing to comply with a condition of an exemption.

Compliance certificates

Pools built, altered or installed before 1 May 2013 will need to obtain a compliance certificate before 1 May 2028 and lodge it with Government within 30 days of issue. Compliance certificates obtained during the transition period will be valid until 1 May 2032.

Pools built, altered or installed on or after 1 May 2013 are not required to obtain a compliance certificate by 1 May 2028 or lodge it with Government. This does not prevent a compliance certificate being obtained before then.

Offences and penalties may apply for failing to meet these obligations.

Maintaining safety around home swimming pools and spas

From 1 May 2024, all owners of a property with a swimming pool or spa are required to maintain their swimming pool or spa safety barriers as an effective and safe child-resistant barrier. All residents of a property with a swimming pool or spa must ensure that all doors, gates and covers providing access to the swimming pool or spa are kept securely closed when not in use. Offences and penalties may apply for failing to meet these obligations.

More information

For more information on the reforms and what they mean for you and your pool, including disclosure obligations on sale or lease of your property, visit the [Home Swimming Pool Safety Reforms](https://www.planning.act.gov.au/projects-priorities/home-swimming-pool-safety-reforms) webpage on the ACT Government planning website: <https://www.planning.act.gov.au/projects-priorities/home-swimming-pool-safety-reforms>

Certificate of Currency

Policy Number	BP20200022
Item 1 The Insured:	Residential Reports Pty Ltd
Item 2 Address:	35 Poynton Street HUGHES ACT 2805
Item 3 Professional Services covered by this policy:	Pre Purchase Building Inspections (AS4349.1) Special Purpose Building Inspections Energy Rating Reports Urban Pest Management Termite Management including inspections - existing buildings and structures (AS3880.2) Timber Pest Inspections (AS4349.3)
Item 4 Description of the Policy:	Professional Indemnity & Broadform Liability (CGU PIB 03-17)
Item 5 Period of Insurance:	From 20/07/2025 To 4.00 pm on 20/07/2026
Item 6 Particulars of Risk:	
	<u>Civil Liability Professional Indemnity</u>
6.1 The Policy Limit is	\$5,000,000 which includes all policy sections
6.2 The Policy Excess is	\$20,000
6.3 The Retroactive Date is	20/07/2020
	<u>Public Liability</u>
6.4 Sum Insured	\$20,000,000
6.5 Excess	\$2,500
Date and Place of Issue	21/07/2025 Melbourne, Victoria

Signed for and on behalf of Insurance Australia Limited ABN 11 000 016 722



Najibi Blisso, Manager

This Certificate of Currency indicates policy cover effective as at the date of issue only

FirstRate Report



YOUR HOUSE ENERGY RATING IS: ★★ ★
in Climate: 24

3 STARS

SCORE: -18 POINTS

Name: J Dessent & A Johnston

Ref No: 46231

House Title: Block 1, Section 46

Date: 17-03-2026

Address: 34 Carrodus Street

Fraser

2615

Reference: C:\REPORTS\...\CARRODUS STREET FRASER 34

IMPROVING YOUR RATING

The table below shows the current rating of your house and its potential for improvement.

Star Rating	POOR			AVERAGE				GOOD				V. GOOD
	0 Star	★	★★	★★★	★★★★	★★★★★	★★★★★★	★★★★★★★	★★★★★★★★	★★★★★★★★★	★★★★★★★★★★	
Point Score	-71	-70	-46	-45	-26	-25	-11	-10	4	5	16	17

Current	-18											
Potential	13											

Incorporating these design options will add the additional points required to achieve the potential rating shown in the table Each point represents about a 1% change in energy efficiency. This list is only a guide to the range of options that could be used.

Design options

Additional points

Change added wall insulation	R 2.5	5
Change added floor insulation	R 2.5	6
Change glass to Double Glazing	100 %	6
Change curtain to	Heavy Drapes & Pelmet	12
Seal Exhaust fans		2
Seal Internal Doors		1

FirstRate Mode
Climate: 24

RATING SUMMARY for: Block 1, Section 46, 34 Carrodus Street, Fraser

Assessor's Name: Lindsay Collison

			Points			
Feature	Winter	Summer	Total			
CEILING	6	1	6			
Surface Area: 0	Insulation: 6					
WALL	-2	-1	-3			
Surface Area: -5	Insulation: 4	Mass: -2				
FLOOR	5	-2	3			
Surface Area: 0	Insulation: 2	Mass: 1				
AIR LEAKAGE (Percentage of score shown for each element)	2	0	2			
Fire Place 18 %	Vented Skylights 0 %					
Fixed Vents 0 %	Windows 29 %					
Exhaust Fans 23 %	Doors 18 %					
Down Lights 0 %	Gaps (around frames) 11 %					
DESIGN FEATURES	0	1	1			
Cross Ventilation 1						
ROOF GLAZING	0	0	0			
Winter Gain 0	Winter Loss 0					
WINDOWS	-17	-10	-27			
Window Direction	Area		Point Scores			
	m2	%NCFA	Winter* Loss	Winter Gain	Summer Gain	Total
NE	13	7%	-14	12	-3	-6
SE	1	1%	-1	1	0	0
SW	22	11%	-18	7	-7	-17
NW	4	2%	-4	0	0	-4
Total	40	21%	-37	20	-10	-27

* Air movement over glazing can significantly increase winter heat losses. SEAV recommends heating/cooling duct outlets be positioned to avoid air movement across glass or use deflectors to direct air away from glass.

The contribution of heavyweight materials to the window score is -1 points

		Winter	Summer	Total
RATING	★ ★ ★	-7	-11	-18*
SCORE				

* includes 0 points from Area Adjustment

Detailed House Data

House Details

ClientName J Dessent & A Johnston
HouseTitle Block 1, Section 46
StreetAddress 34 Carrodus Street
Suburb Fraser
Postcode 2615
AssessorName Lindsay Collison
FileCreated 17-03-2026
Comments

Climate Details

State
Town Canberra
Postcode 2600
Zone 24

Floor Details

ID	Construction	Sub Floor	Upper	Shared	Foil	Carpet	Ins RValue	Area
1	Concrete Slab on ground	No Subfloor	No	No	No	Float Timb	R0.0	26.9m ²
2	Timber	Enclosed	No	No	No	Float Timb	R1.5	66.4m ²
3	Timber	Enclosed	No	No	No	Float Timb	R0.0	6.4m ²
4	Timber	Enclosed	No	No	No	Carp	R0.0	59.0m ²
5	Timber	Enclosed	No	No	No	Tiles	R0.0	5.6m ²
6	Timber	Open	No	No	No	Carp	R0.5	38.6m ²
7	Timber	Open	No	No	No	Float Timb	R0.5	10.2m ²

Wall Details

ID	Construction	Shared	Ins RValue	Length	Height
1	Brick Veneer	No	R1.5	60.4m	2.4m
2	Framed: FC Sheet Clad	No	R1.5	29.1m	2.4m

Ceiling Details

ID	Construction	Shared	Foil	Ins RValue	Area
1	Attic - Standard	No	Yes	R4.2	213.1m ²

Window Details

ID	Dir	Height	Width	Utility	Glass	Frame	Curtain	Blind	Fixed & Adj Eave	Fixed Eave	Head to Eave
1	SW	2.1m	3.7m	No	DG	ALIMPR	VE	Yes	0.6m	0.6m	0.0m
2	SW	1.8m	1.4m	No	SGT	TIMB	NC	No	3.1m	3.1m	0.2m
3	SW	2.1m	1.2m	No	DG	ALIMPR	VE	Yes	0.6m	0.6m	0.0m
4	SW	2.1m	1.2m	No	DG	ALIMPR	VE	Yes	0.6m	0.6m	0.0m
5	SW	2.1m	1.2m	No	DG	ALIMPR	VE	Yes	0.6m	0.6m	0.0m
6	SE	1.1m	0.9m	No	DG	ALIMPR	NC	No	0.6m	0.6m	0.8m
7	NE	2.1m	1.2m	No	SG	ALSTD	VE	No	0.6m	0.6m	0.0m
8	NE	1.0m	0.9m	Yes	SG	ALSTD	VE	No	0.6m	0.6m	0.0m
9	NE	1.0m	0.6m	Yes	SG	ALSTD	VE	No	0.6m	0.6m	0.0m
10	NE	1.0m	0.6m	Yes	SG	ALSTD	HB	No	0.6m	0.6m	0.0m
11	NE	1.8m	1.2m	No	SG	ALSTD	HB	No	0.6m	0.6m	1.0m
12	NE	1.8m	1.2m	No	SG	ALSTD	HB	No	0.6m	0.6m	1.0m
13	NW	2.1m	1.8m	No	SG	ALSTD	HB	No	10.2m	10.2m	0.4m
14	NE	1.2m	1.9m	No	SG	ALSTD	VE	No	8.2m	8.2m	0.4m
15	SW	1.5m	0.9m	No	SG	ALIMPR	HB	No	0.6m	0.6m	0.0m
16	SW	1.5m	0.9m	No	SG	ALIMPR	HB	No	0.6m	0.6m	0.0m
17	SW	1.5m	0.9m	No	SG	ALIMPR	HB	No	0.6m	0.6m	0.0m

18 NE 1.2m 1.8m No SG ALIMPR VE No 0.6m 0.6m 0.0m

Window Shading Details

ID	Dir	Height	Width	Obst Height	Obst Dist	Obst Width	Obst Offset	LShape Left Fin	LShape Left Off	LShape Right Fin	LShape Right Off
2	SW	1.8m	1.4m	0.0m	0.0m	0.0m	0.0m	0.9m	0.0m	0.9m	0.0m
7	NE	2.1m	1.2m	0.0m	0.0m	0.0m	0.0m	4.9m	6.2m	0.0m	0.0m
8	NE	1.0m	0.9m	0.0m	0.0m	0.0m	0.0m	4.9m	3.1m	0.0m	0.0m
9	NE	1.0m	0.6m	0.0m	0.0m	0.0m	0.0m	4.9m	1.8m	0.0m	0.0m
10	NE	1.0m	0.6m	0.0m	0.0m	0.0m	0.0m	4.9m	0.0m	0.0m	0.0m
13	NW	2.1m	1.8m	2.4m	10.2m	6.1m	-1.2m	10.0m	1.4m	0.0m	0.0m
14	NE	1.2m	1.9m	0.0m	0.0m	0.0m	0.0m	6.2m	8.2m	4.9m	0.0m

Zoning Details

Is there Cross Flow Ventilation ? Good

Air Leakage Details

Location Suburban
 Is there More than One Storey ? Yes
 Is the Stairwell Separated by Doors ? No
 Is the Entry open to the Living Area ? No
 Area of Heavyweight Mass 0m²
 Area of Lightweight Mass 0m²

	Sealed	UnSealed
Chimneys	1	0
Vents	0	0
Fans	1	1
Downlights	0	0
Skylights	0	0
Utility Doors	0	3
External Doors	0	1

Unflued Gas Heaters 0
 Percentage of Windows Sealed 98%
 Windows - Average Gap Small
 External Doors - Average Gap Small
 Gaps & Cracks Sealed Yes

Rater Comments

House Details

ClientName	J Dessent & A Johnston
HouseTitle	Block 1, Section 46
StreetAddress	34 Carrodus Street
Suburb	Fraser
Postcode	2615
AssessorName	Lindsay Collison
FileCreated	17-03-2026

Rater Comments

MEASUREMENTS USED IN THIS ASSESSMENT

The Energy Rating recorded in this assessment is determined by assessing many elements of the structure and interior treatments including window and floor coverings. The area of external walls and windows, ceiling and floors are part of the assessment.

Some measurements used in this assessment may be nominal. Every effort is made by the assessor to accurately calculate the dimensions of property. However, often accurate and comprehensive plans indicating all dimensions of an existing property, particularly following alterations and extensions are not always available. The reader of this report should not rely on the accuracy of any dimensions used when making critical decisions relating to those dimensions. The assessor will not accept any liability should any discrepancy be revealed.

DESIGN OPTIONS

The design option suggestions to improve this energy rating may be additional to elements already in place. For example, the option to install 'Heavy Drapes and Pelmet' will take into account windows that already have Heavy Drapes and Pelmet installed. Insulation recommendations will take into account existing insulation values.

Some recommendations for improvement will not be practical in all circumstances. For example, if the dwelling is built on a concrete slab, it will be possible to install floor insulation.

DOOR SEALS AND WEATHER STRIPS

A wooden framed door is only considered to be sealed when a draft extruding device is fitted to the bottom of the door AND sealing tape or felt is fitting to the timber frame around the door opening.

WINDOW GLAZING RATIOS

Glazing areas in one direction greater than 25% of the nett conditioned floor area will reduce the Energy Efficiency Rating.

CONVEYANCING BUILDING FILE INDEX

SUBURB: **FRASER**

SECTION: **46**

BLOCK: **1**

UNIT: **N/A**

EX GOV: **NO**

COU ISSUED Y/N	PLAN NUMBER	FOLIO NO.	DESCRIPTION OF WORK	AMEND	DETAILS	PERMIT NUMBER	COU PLAN NO. & DATE
Y	39256	2	BRICK VENEER RESIDENCE				
		6				39256	
Y	39256/A	10		Y			
		25					39256+/A 06/11/1975
Y	39256/B	26	GARAGE & CARPORT				
		28				39256/B	
		32					39256/B 31/05/1977
Y	39256/C	33	ABOVE GROUND SWIMMING POOL				
		35				39256/C	
N/A	39256/D	37	SUPERSEDED				
Y	39256/E	39	BRICK VENEER ADDITIONS TO RESIDENCE				
		41				39256/E	
Y	39256/F	54		Y			
		66					39256/D 28/02/1983
		68					39256/E+/F 28/02/1983
Y	39256/G	69	PERGOLA & FIREPLACE				
		76				39256/G	
		80					39256/G 05/08/1985
Y	01266/A	92	ADDITIONS TO RESIDENCE & GARAGE			01266/A	
		103					01266/A 06/07/2001
Y	B2022264/A	-	ALTERATIONS TO RESIDENCE – EXISTING ROOF CLADDING, WINDOW INSTALLATIONS, COVERED ALFRESCO & COVERED PERGOLA			B2022264/A	
		-					B2022264/A 31/01/2022

Y	B20225225/A	-	NEW SWIMMING POOL & FENCE			B20225225/A	
		-					B20225225/A 20/05/2024

For any incomplete approvals please email acbuildingconveyance@act.gov.au for further information on how to complete.

Drainage Plan Number: 26886

Survey: Y (1)

Comments: COU ON FOLIO NO.66 SHOULD READ PLAN NO. 39256/C.

NO PLANS ON FILE FOR 39256/G.

CONVEYANCING PART 2

No information is provided in respect of electrical, drainage or sewer matters and or to the location of overhead power lines or underground cables in relation to the building.

	<u>Yes</u>	<u>No</u>
1. (a) Is this a government or ex government house?	<input type="checkbox"/>	<input checked="" type="checkbox"/>
(b) If yes, is there a building file with approvals on it?	<input type="checkbox"/>	<input type="checkbox"/>
2. Is there any record of incomplete building work on the building file? If yes - file copies attached	<input type="checkbox"/>	<input checked="" type="checkbox"/>
3. Are there any records on the building file of current (within 5 years) housing Indemnity insurance policies for building work? If yes - file copies attached	<input type="checkbox"/>	<input checked="" type="checkbox"/>
4. Are there any records on the building file showing building applications still being processed? (Current within 3 years) If yes - file copies attached	<input type="checkbox"/>	<input checked="" type="checkbox"/>
5. Are there any records on the building file in relation to loose-fill asbestos insulation?	<input type="checkbox"/>	<input checked="" type="checkbox"/>

If available, copies of the following documents are provided:

• Certificate/s of Occupancy and Use	<input checked="" type="checkbox"/>	<input type="checkbox"/>
• Survey Certificates	<input checked="" type="checkbox"/>	<input type="checkbox"/>
• Unit Plan/Unit Entitlements (if property is unit titled)	<input type="checkbox"/>	<input checked="" type="checkbox"/>
• Approved Building Plans	<input checked="" type="checkbox"/>	<input type="checkbox"/>
• Ex- government Building Plans*	<input type="checkbox"/>	<input checked="" type="checkbox"/>

If requested:

• Drainage Plan(s)	<input checked="" type="checkbox"/>	<input type="checkbox"/>
--------------------	-------------------------------------	--------------------------

ASBESTOS

The ACT Government is not able to guarantee the accuracy of the information in this report.

You should make your own enquiries and obtain reports (from a licensed Asbestos Assessor) in relation to the presence of loose fill asbestos insulation (and other forms of asbestos) on the premises. For more information go to the Asbestos Awareness Website –

www.asbestos.act.gov.au

Please note: Development Approval plans will not be included in this report (We do not receive Development Approval Plans unless they are part of a Building Approval in which case they become Building Approval Plans), if development approval was granted you can request copies of the Development Approval plans from ACEPDcustomerservices@act.gov.au.

Please Note: Building approvals that have been generated via eDevelopment will be issued with a project number prefixed by the letter B. Initial building approval documentation will be identified with project number B20XXXX only but will be referenced as B20XXXX/A on the Certificate of Occupancy and Use. Any amendments to the original approval will be issued with the project number and an alphanumeric digit. The first amendment will be identified as B20XXXX/B, the second amendment B20XXXX/C etc. Not all eDevelopment plans will be stamped with the plan number.

***Ex Government plans:** Plans are typical and not specific to each residence. There may be slight changes to the layout or window locations that were not required to be approved.

Search officer comments (if any?)

Search officer initials: Ashleigh

Cost of application: \$ 144.79

Date completed:

13/03/2026

PHONE: 48 0434

K. F. MICHNIEWICZ

M.I.S. Aus., A.R.I.C.S. (G.B.)

LAND & ENGINEERING SURVEYOR

Registered under Surveyors Act (1929)

Registered in A.C.T.

55 CRESWELL STREET
CAMPBELL, A.C.T. 2601

39256
PA 30/6/75

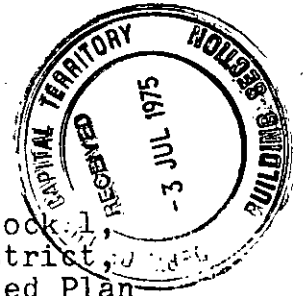

SURVEYOR'S CERTIFICATE.

All that piece or parcel of land being Block 1, Section 46, Division of FRASER, Canberra City District, Australian Capital Territory, as shown on Deposited Plan No. 3726.

I certify that I have surveyed the above mentioned land shown by red edging on the sketch hereunder.

I find thereon in course of erection one Brick-Veneer House, which is well within the boundaries of the land referred to.

There are no encroachments by or upon this land.

K. F. Michniewicz
REGISTERED SURVEYOR.

2.7.1975.

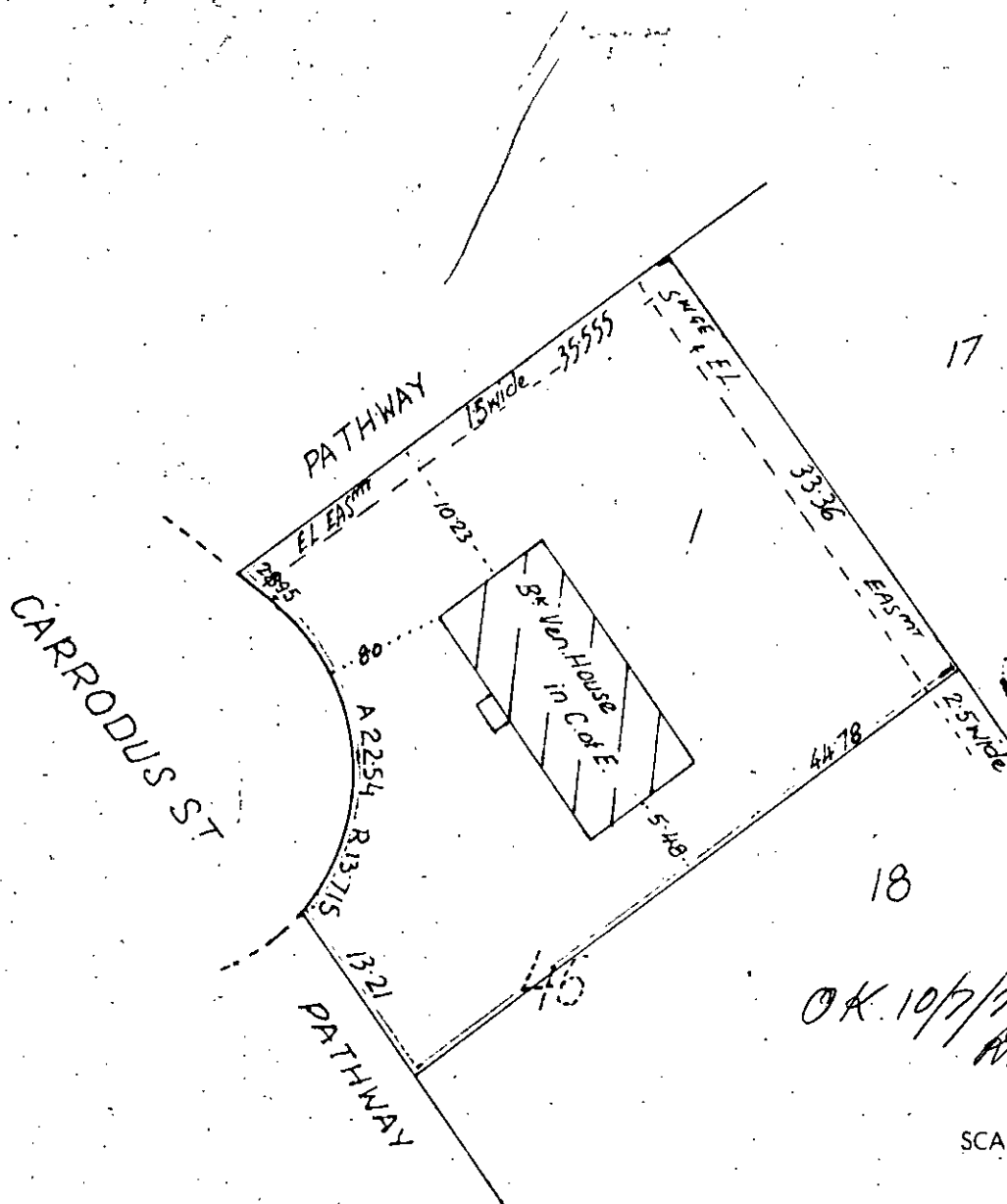

OK 10/7/75
[Signature]



SCALE 1:500

Department of the Capital Territory
Building Section

CERTIFICATE OF FITNESS
(CLASS AND X OCCUPANCY ONLY)

BL1/8(9/75)

Australian Capital Territory
Building Ordinance 1972 - 74
(Part V)

It is hereby certified that the building consisting of a Brick Venetian Residence
.....
.....
..... situated on

Block <u>1</u>	Section <u>46</u>	Division <u>FRASER</u>
or situated at		

for which plans and specifications were approved and a Building Permit issued under the provisions of the Building Ordinance 1972, is fit for use and/or occupation.

Approved plan no. <u>39256 & 39256/A</u>		
Type of construction *	Class of occupancy *	Number of storeys
Permit no. <u>25296</u>	Name of permit holder <u>A. BALAZS</u>	

*As defined in the Building Manual A.C.T.

25026 [Signature] 6/11/75
Deputy-Building Controller

BUILDING (DESIGN AND SITING)
 ORDINANCE 1964 AS AMENDED
 APPROVAL GRANTED 12 FEB 1975
 DELEGATE *[Signature]*
 NATIONAL CAPITAL
 DEVELOPMENT COMMISSION

PLANS/FILE No. 39256
 Received Building Section
 - 7 FEB 1975 S13
 Dept. of the Capital Territory

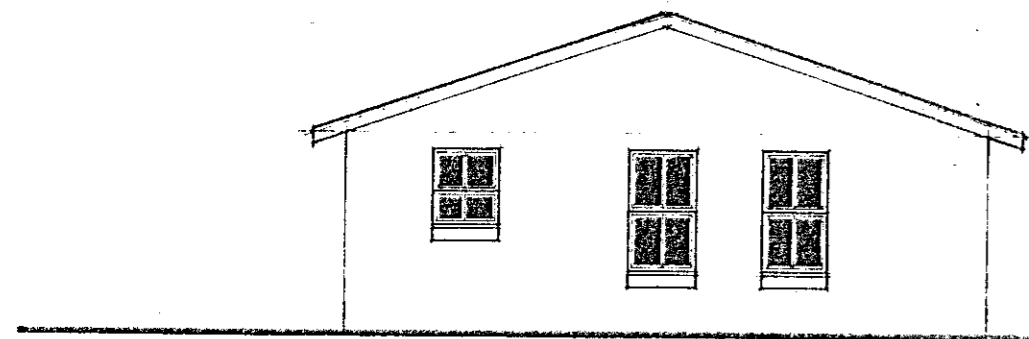

SIDE ELEVATION

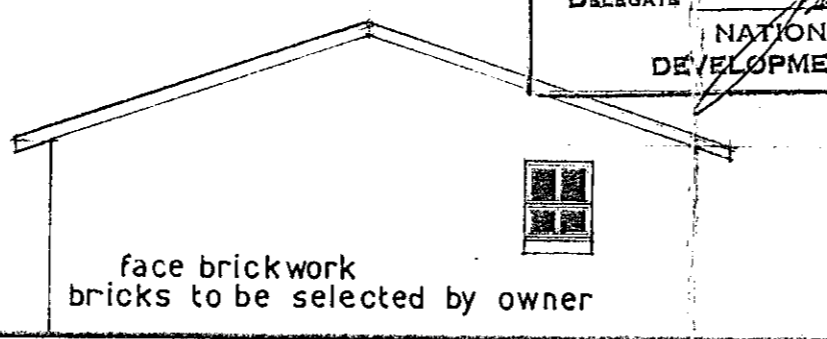

SIDE ELEVATION

face brickwork
bricks to be selected by owner

2400

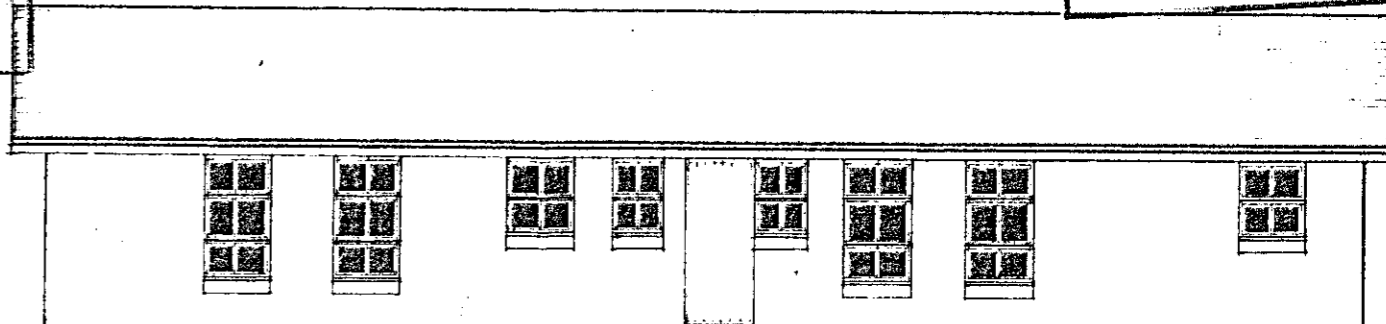

REAR ELEVATION

ceiling line
floor line
ground line

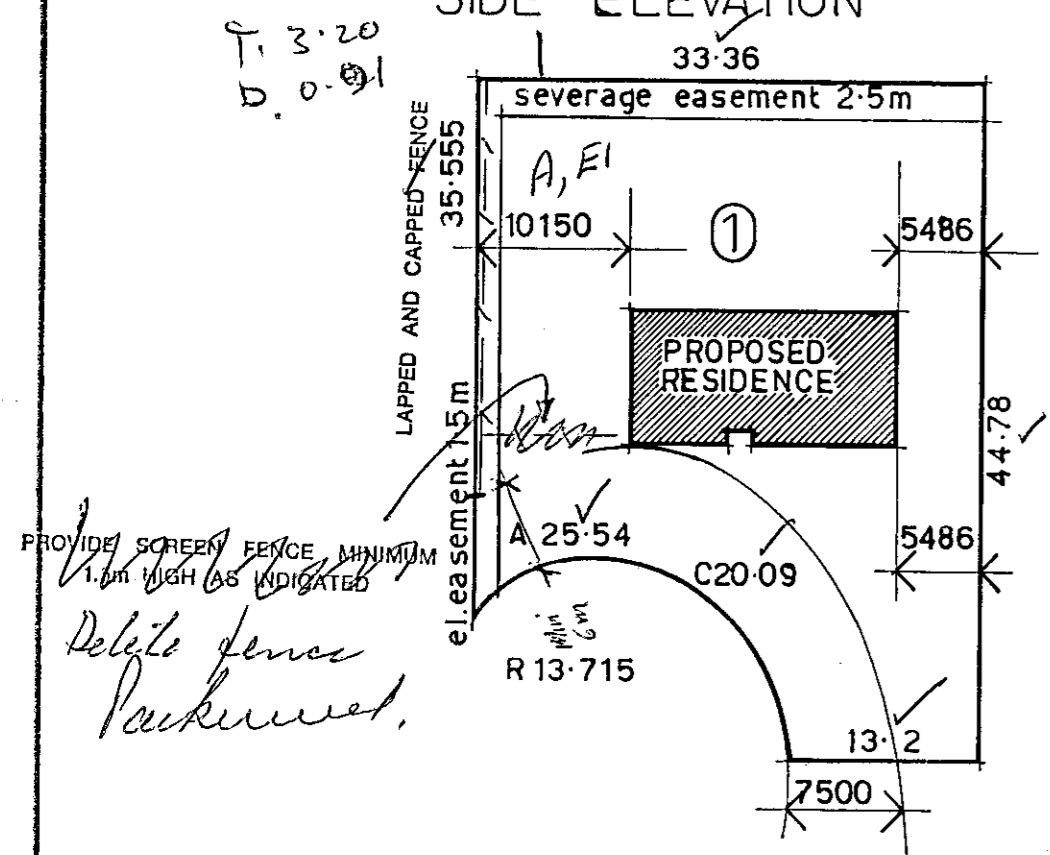

SITE PLAN

P. 3.20
D. 0.01
LAPPED AND CAPPED FENCE 35.555
easement 1.5m
PROVIDE SCREEN FENCE, MINIMUM 1.0m HIGH AS INDICATED
Delete fence Parkhurst.

UNIT SIZE AS PER TRUSS MANUFACTURERS CHART

truss system as detailed

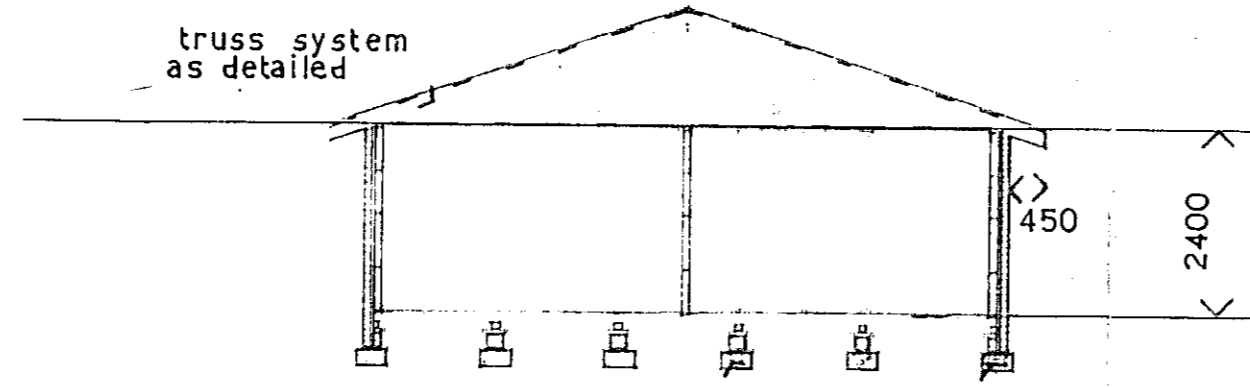

SECTION A-A

400x230 with f.8.t.m.bottom
footings deep 250x350

NOTE
FOOTINGS TO BE TAKEN DOWN TO SOLID GROUND
THE BUILDING TO BE CONSTRUCTED IN ACCORDANCE WITH THE BUILDING MANUAL A.C.T. AND S.A.A. CODES OR AS DIRECTED.

THE WINDOWS IN THE FAMILY ROOM CAN BE OMITTED AND REPLACED BY 2400 WIDE SLIDING DOOR IF OWNER WISHES TO DO SO.

concrete roofing tiles at 18° pitch

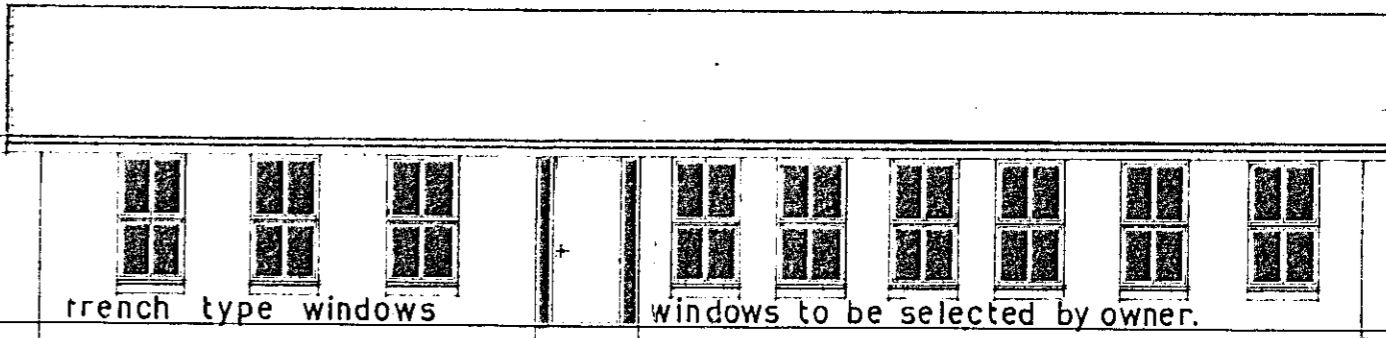

FRONT ELEVATION

ceiling line
floor line
ground line

Building to be constructed in accordance with the Building Manual A.C.T.
All materials and equipment to be confined to the lowest cost.
Applications to use natural stone or other unadorned land to be lodged in writing with Land Services Section

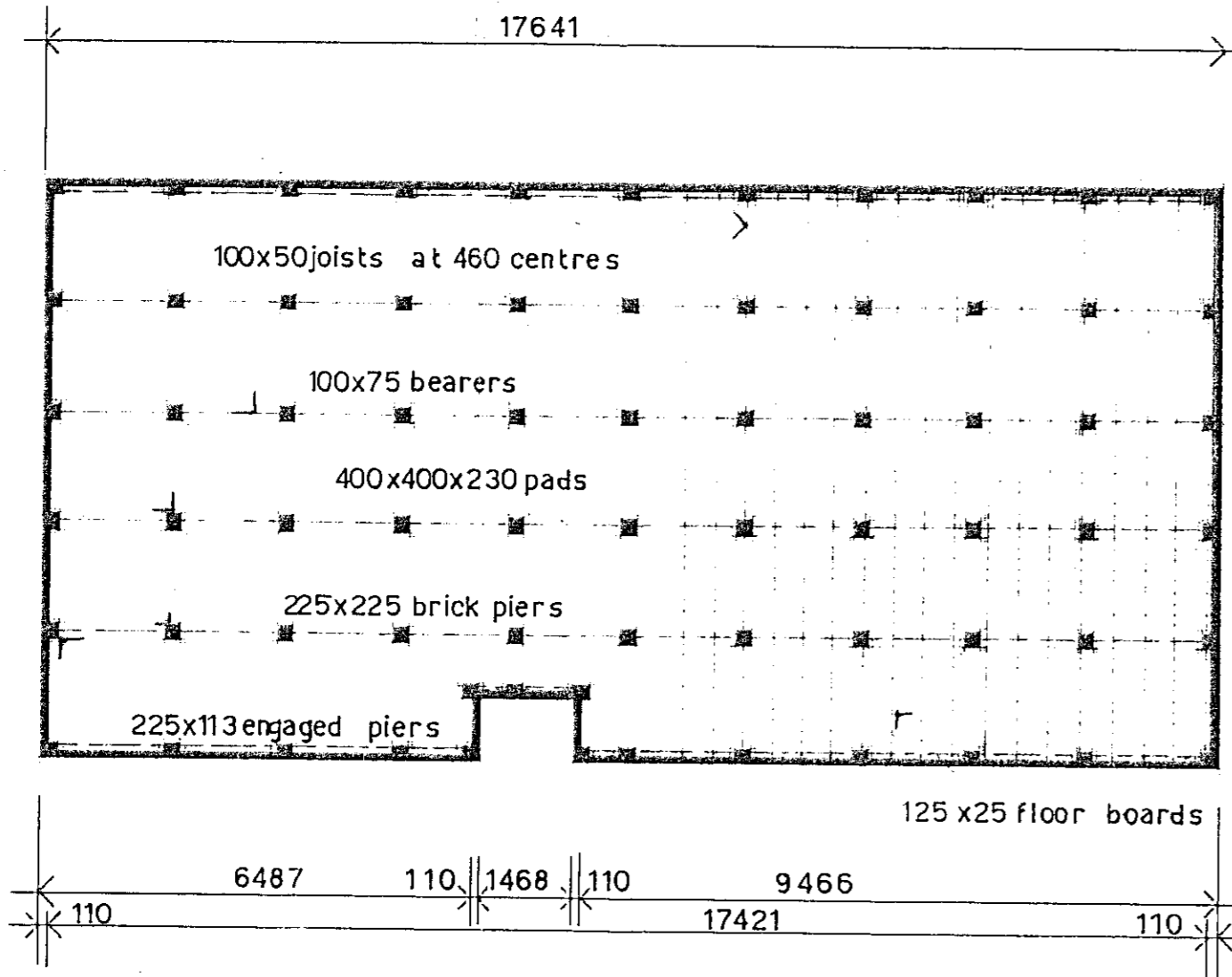

FOUNDATION PLAN

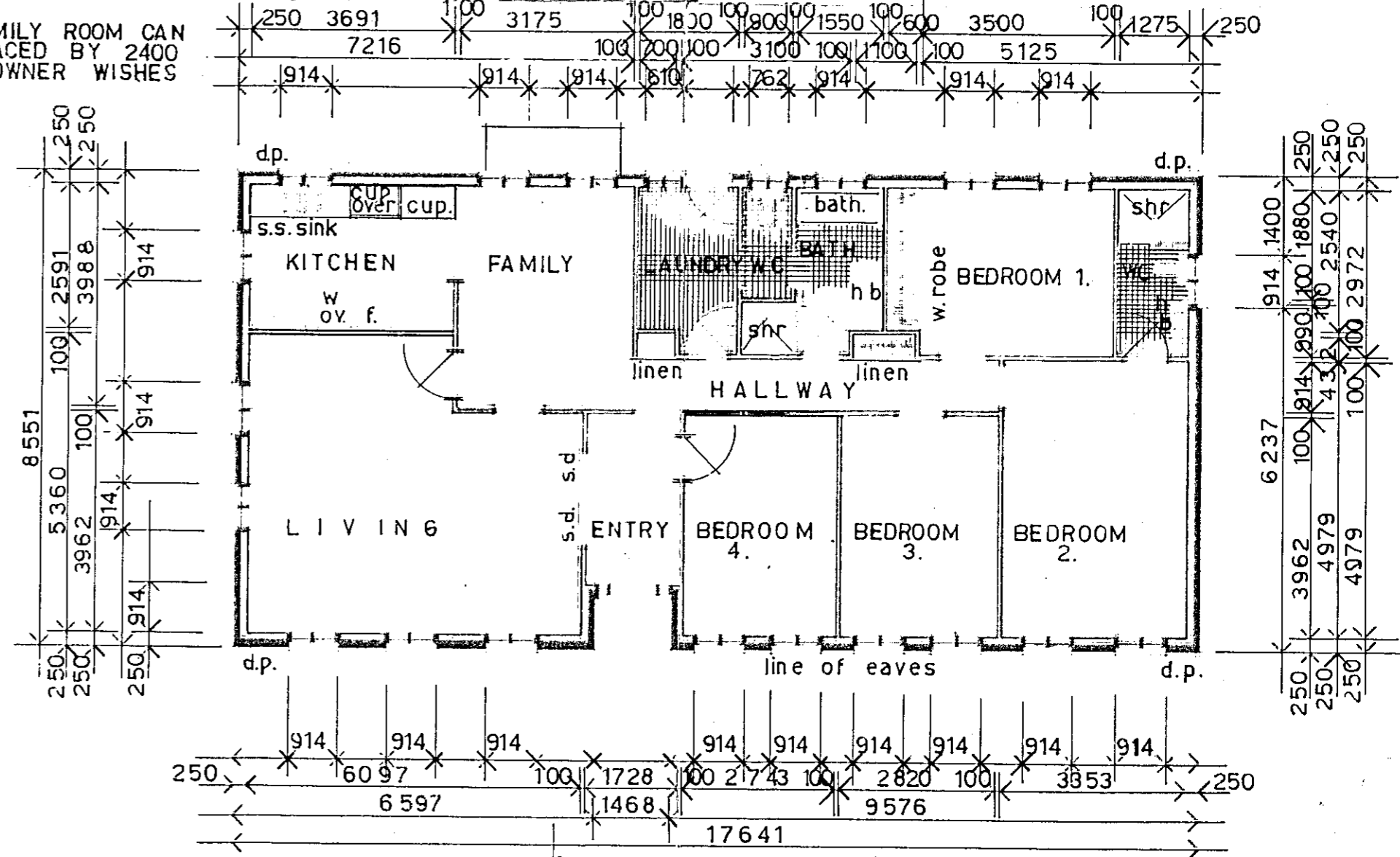

FLOOR PLAN

JOB NUMBER	SCALE AREA	NOTE	NOTE	OWNER OF PROPOSED BRICK VENEER BUILDING
B.V.10.C.	SCALE 1:100 & 1:500 AREA = 16.00 sqs	THIS DRAWING SHALL NOT BE SCALED. THIS DRAWING IS COPYRIGHT AND SHALL NOT BE COPIED IN WHOLE OR IN PART OR USED FOR ANY PURPOSE.	ALL DIMENSIONS TO BE CHECKED ON SITE BY THE BUILDER PRIOR TO COMMENCEMENT OF WORKS.	PROPOSED BRICK VENEER RESIDENCE TO BE ERECTED ON BLOCK 1, SECTION 46 FRASER A.C.T. FOR MR. A. AND MRS. J. BALAZS OF 31 LACHLAN STREET MACQUARIE A.C.T.

39256/A

1/46 FRASER

Building Section

17 1975 5/2

REVISIONS
 SPECIFICATION OF PINUS RADIATA WALL FRAMES AS MANUFACTURED
 BY GLENROY BUILDING SUPPLIES

All F8 grade, mechanically stress graded for external load bearing walls.

Top plate	double	70 x 35	grade	F5	Pinus Radiata
Bot plate	single	70 x 35	"	F5	" "
Studs @ 450 mm	C-C	70 x 45	"	F8	" "
Window Studs (double)		70 x 45	"	F8	" "
Braces		70 x 35	"	F5	" "
Nogging 1 row		70 x 35	"	F5	" "
Lintols up to 1100 span		100 x 70	"	F8	
" 1200mm - 1700mm span		140 x 70	"	F8	
" 1700 - 2400mm span		220 x 70	"	F8	

over 2.4m and for concentrated roof loading appropriate steel section.

Trusses to be located over studs and bottom plate to be blocked to bearer under all loadbearing studs.

External non loadbearing walls.

Top plate single	70 x 35	Grade	F5
Bot plate single	70 x 35	"	F5
Studs @ 450mm C.C.	70 x 45	"	F5
Window studs (double)	70 x 45	"	F8
Braces	70 x 35	"	F5
Nogging 1 row	70 x 35	"	F5

Building to be constructed in accordance with the Building Manual
 N.C.T.

Internal non loadbearing wall to be confined to the boxed area.
 Appropriate use nature strips or other uninclosed land to be lodged
 in writing with Land Services Section

Plates	70 x 35	Grade	F5
Studs @ 450mm C.C.	70 x 35	"	F5
Braces	70 x 35	"	F5
Nogging	70 x 35	"	F5
Door Heads	70 x 35	"	F5
Connector Plates - Plate-stud-brace connection	2/100	x	75
(Sanford) Stud-nogging-brace	"	2/200	x 50
Ext. stud-plate	"	2/25	x 100
Int. stud-plate	"	2/25	x 75
Nogging-stud	"	1/25	x 100

Department of the Capital Territory
Building Section

CERTIFICATE OF FITNESS

(CLASS 1 AND X OCCUPANCY ONLY)

BL1/8(9/75)

Australian Capital Territory
Building Ordinance 1972-74
(Part V)

32

It is hereby certified that the building consisting of.....

Garage & Carport

..... situated on

Block <i>1</i>	Section <i>46</i>	Division <i>Fraser</i>
or situated at		

for which plans and specifications were approved and a Building Permit issued under the provisions of the Building Ordinance 1972, is fit for use and/or occupation.

Approved plan no. <i>39256/B</i>		
Type of construction*	Class of occupancy*	Number of storeys
Permit no. <i>21956</i>	Name of permit holder <i>Boddy & Collins PL</i>	

*As defined in the Building Manual
A.C.T.

No

35281

Southwell 31/5/77
Deputy Building Controller

GARAGES

CARPORTS

GARDEN SHEDS



BODDY & COLLINS Pty Ltd.

289 CANBERRA AVENUE, Fyshwick 2609 A.C.T.

P.O. BOX 328
FYSHWICK

HOLIDAY HOMES

Telephone :
95 0648

Proposed siting for a garage/carport to be erected for

Mr. BRETT of 34 CARRODUS ST.
on Block 1 Section 46 Suburb FRASER
Size 10900 x 5100 x 2100

Received: Building Section

- 7 APR 1977 9/2

Dept. of the Capital Territory

Builder to erect unit and

Owner to level and prepare site, encase stormwater and/or sewerage line if found to be necessary.

DEPARTMENT OF THE CAPITAL TERRITORY
DEPARTMENTAL RECORDS INDICATE THAT PORTION
OF THE EXISTING SANITARY DRAINAGE SERVICE
WILL BE UNDER THE PROPOSED STRUCTURE
THE MINIMUM COVER IS MAINTAINED
NO FURTHER ACTION IS REQUIRED

SITE PLAN.

Scale: 1 : 500

Building to be constructed in accordance with the Building Manual
A.C.T.
All materials and equipment to be confined to the leased area.
Applications to use nature strips or other unleased land to be lodged
in writing with Land Services Section

"NO SURVEY CERTIFICATE REQUIRED."
LESSEE/BUILDER RESPONSIBLE FOR CORRECT SITING

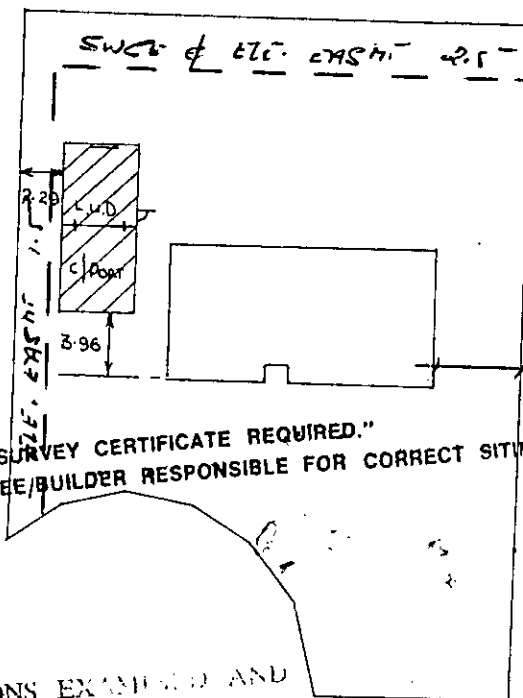

BUILDINGS (E.S. H. AND SITING)
ORDINANCE 1511 AS AMENDED
APPROVAL C
13 APR 1977
DELEGATE NATIONAL COMMISSION
DELEGATE

PLANS AND SPECIFICATIONS EXAMINED AND
RECOMMENDED FOR APPROVAL BY

ENGINEER FOR WATER SUPPLY AND SEWERAGE

CHIEF ELECTRICAL ENGINEER

STRUCTURAL ENGINEER

SENIOR TECHNICAL OFFICER

The proposed structure shown on this plan has
been sited clear of the electricity service to the
residence, and may be erected on the site indicated.

CHIEF ELECTRICAL ENGINEER
A. C. T. E. A.

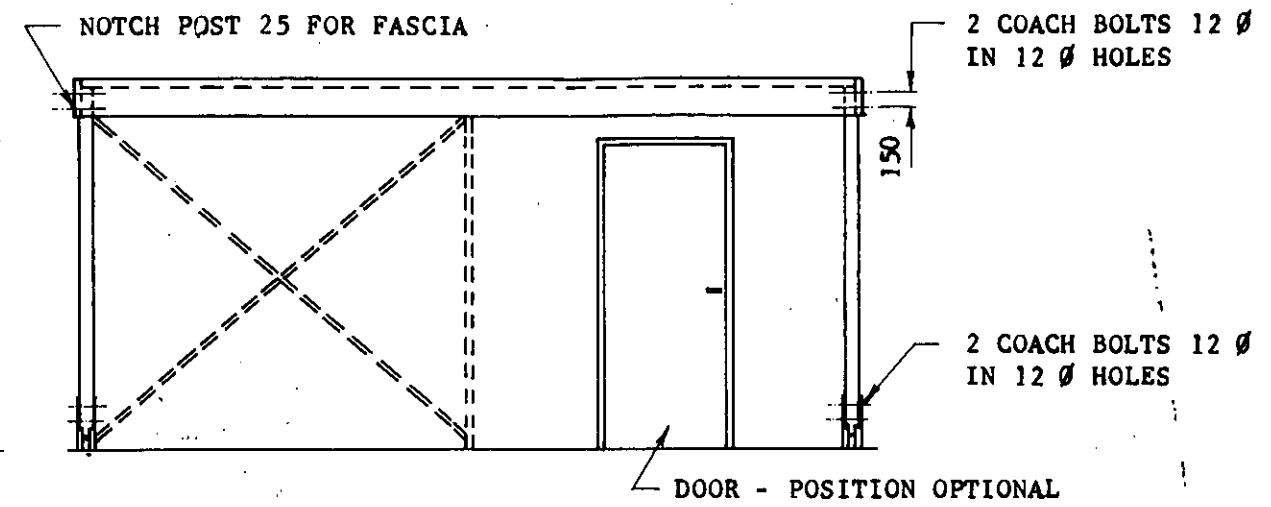
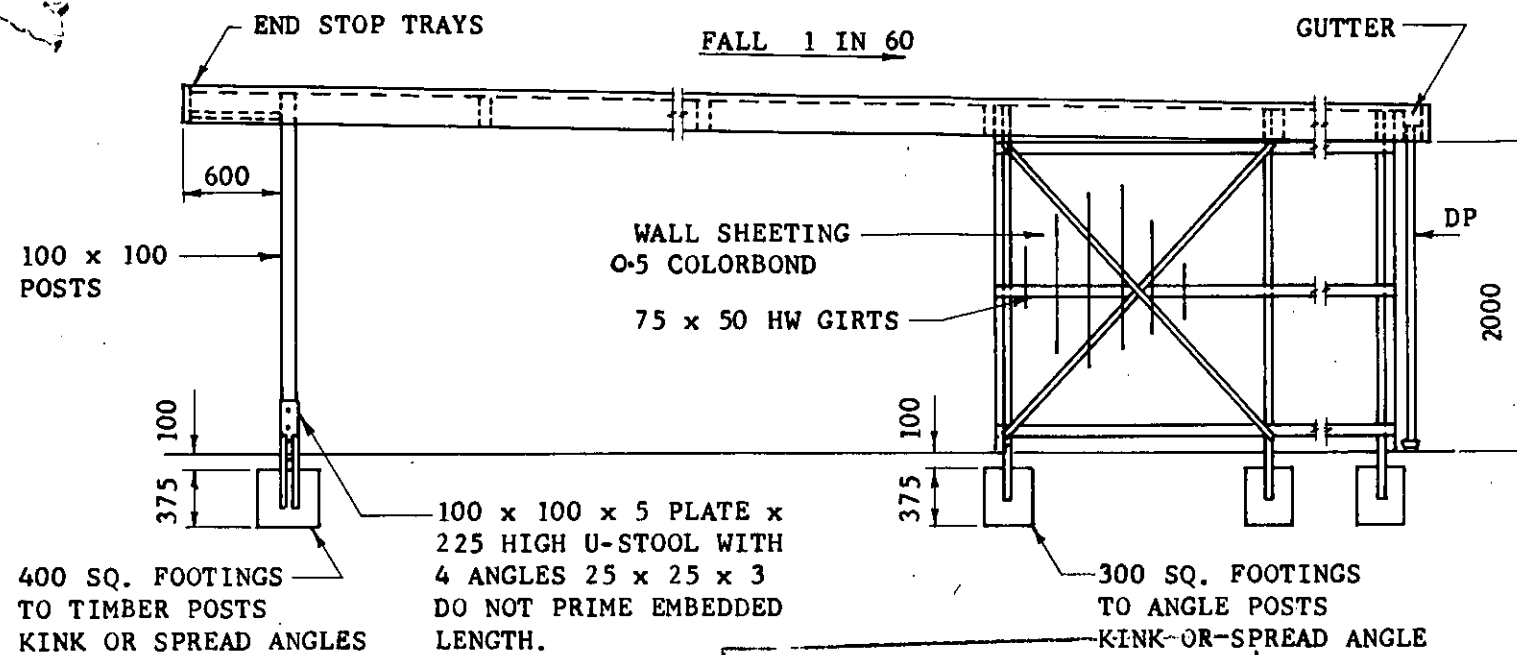

FRONT VIEW

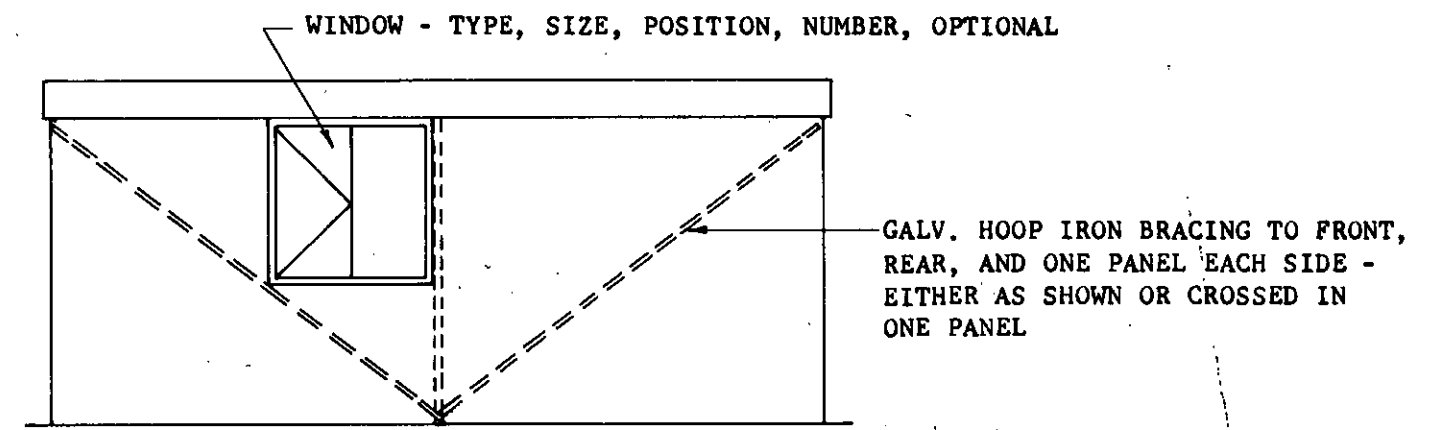

REAR VIEW

SIDE VIEWS (DESIGN AND SITING)
ORDINANCE 1964 AS AMENDED
APPROVAL GRANTED
13 APR 1977
M. Carr
CITY ENGINEER
MUNICIPALITY OF BODDYPART
CITY COMMISSION

44 x 44 x 3 ANGLE BACKING TO MITRE CORNERS & CARPORT BEAMS. 2 BOLTS 6 Ø TO EACH LEG

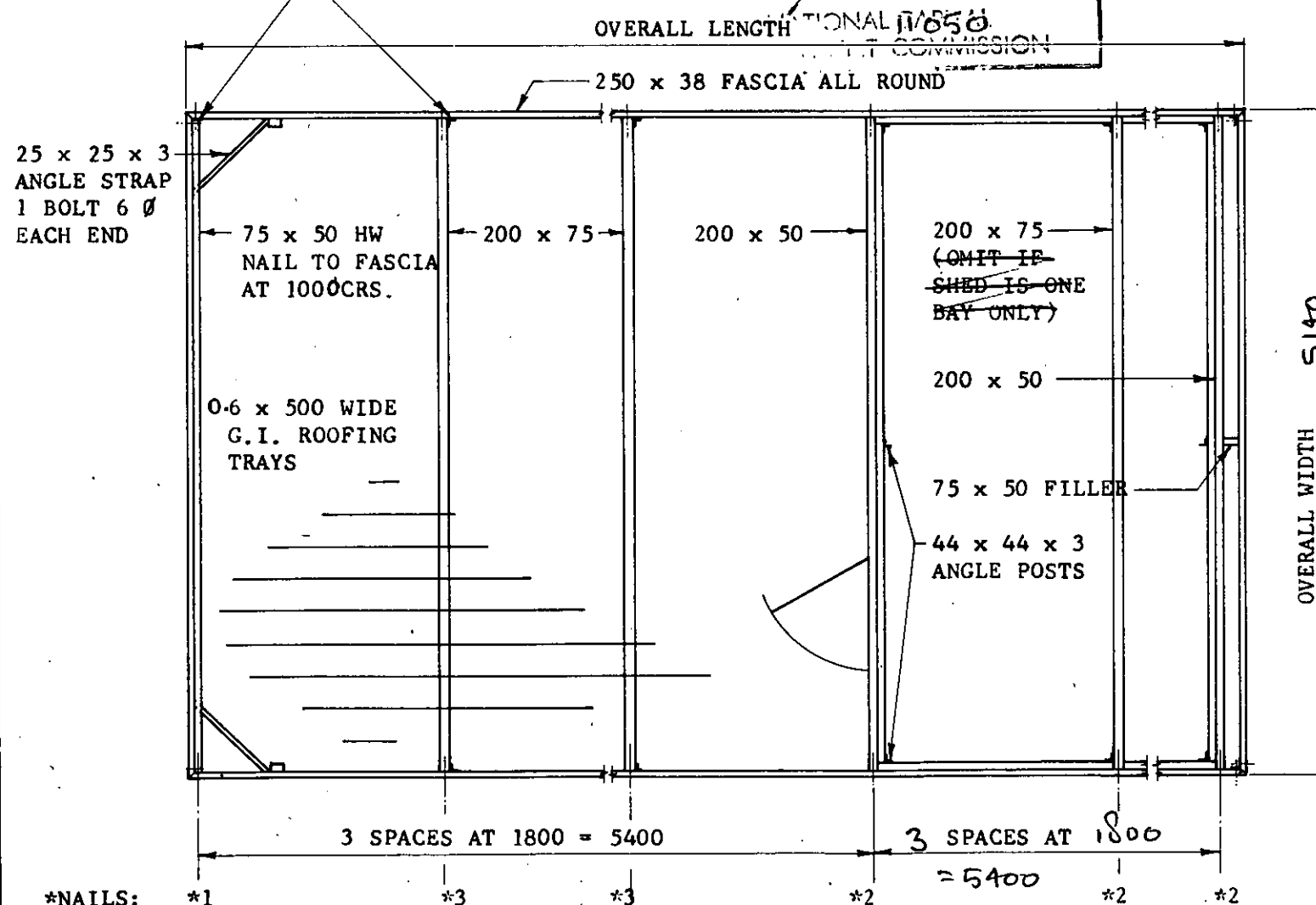

PLAN (NOT TO SCALE)

- NOTES
1. CONSTRUCTION TO BE IN ACCORDANCE WITH THE BUILDING MANUAL A.C.T.
 2. CONNECT DOWNPIPE TO EXISTING STORMWATER
 3. ENCASE POSTS TO GROUND LEVEL IF OWNER DOES NOT INTEND TO POUR SLAB - OWNER TO ADVISE.
 4. DESIGN LOADS ARE TO AS CA34 PARTS I & II WIND CATEGORY 3
 5. DESIGN IN ACCORDANCE WITH AS CA65 DESIGN DEFLECTION = 1/180 SPAN (MAX.)
 6. UNLESS NOTED, TIMBER TO BE ROUGH SAWN SELECT MERCHANT GRADE OREGON
 7. * STRUCTURAL NAILED JOINT EACH END - NAILS 5 x 125 MIN. HOLES MAY BE PREDRILLED 3 DIA. NUMBER SHOWN ARE MINIMUM WITHOUT SPLITTING

MR <i>Brett</i>	BLOCK 1	SECTION 46 FRAMER
PROPOSED TIMBER FRAMED CARPORT-SHED MANUFACTURED BY BODDY & COLLINS PTY.LTD. PO BOX 328 FYSHWICK PH 950648		
RAY FRANZI M.I.E.AUST. CONSULTING ENGINEER PH.811149 P.O. BOX 7 JAMISON CENTRE A.C.T. 2614	SCALE 1:50	DRG. NO. GR 2 C

COPYRIGHT

PLAN OF SITING OF ABOVE GROUND SWIMMING POOL



OWNER: MR. & MRS. M. BRETT
BLOCK 11 SECTION 46

SCALE 1:500

PLANS/FILE No. 392564
Received Building Section
26 OCT 1979
Dept. of the Capital Territory

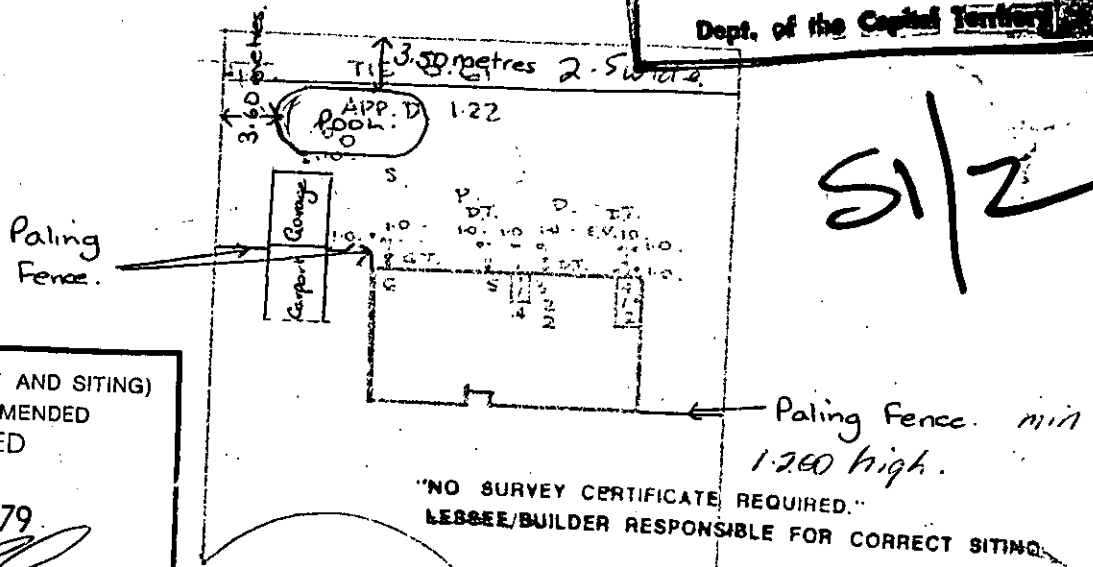

S1/2

BUILDINGS (DESIGN AND SITING)
ORDINANCE 1934 AS AMENDED
APPROVAL GRANTED

1-NOV 1979

DELEGATE *[Signature]*
NATIONAL CAPITAL
DEVELOPMENT COMMISSION

"NO SURVEY CERTIFICATE REQUIRED."
LESSEE/BUILDER RESPONSIBLE FOR CORRECT SITING.

BUILDING WORK SHALL BE CONSTRUCTED IN ACCORDANCE WITH THE APPROVED PLANS THE BUILDING MANUAL ACT, THE NOTATIONS MADE ON THE PLANS AND ANY MATTERS SPECIFIED ON THE BUILDING PERMIT. THE APPROVAL OF PLANS OR THE GRANT OF A BUILDING PERMIT DOES NOT AFFECT THE OPERATION OF ANY OTHER LAW IN THE TERRITORY, NOR DOES IT AUTHORISE THE USE OF THE LAND CONTRARY TO A PROVISION, COVENANT OR CONDITION OF LEASE.

MODIFICATIONS IF APPLICABLE

Pool SIZE: 8.2m x 4.5 m x 1.2 m deep

CLARKES model no 2715.

- NOTE:
1. DRAINS TO BE LAID SHOWN IN BLUE LINES.
 2. THIS PLAN TO BE READ IN CONJUNCTION WITH APPROVED ARCHITECTURAL PLANS AND SPECIFICATIONS.
 3. DRAINS TO BE SUPPORTED ON OR FROM SOLID GROUND.
 4. SEWER BRANCH TO BE LOCATED ON SITE BEFORE ANY WORK IS COMMENCED.
 5. EXISTING DRAINS SHOWN IN GREEN LINES.
 6. EXISTING DRAINS TO BE ABOLISHED TO APPROVAL.

DEPARTMENT OF CONSTRUCTION

DEPARTMENTAL RECORDS INDICATE THAT PORTION OF THE EXISTING SANITARY DRAINAGE SERVICE WILL BE UNDER THE PROPOSED STRUCTURE, PROVIDED THE MINIMUM COVER IS MAINTAINED OVER THE PIPES NO FURTHER ACTION IS NECESSARY.

[Signature]
Garage Engineer
24.5.1975

APPROVED FOR CONSTRUCTION BY THE HOLDER OF A CLASS "D" LICENCE.
CLASS OF OCCUPANCY: RESIDENCE I
ARTICLE 163 X

[Signature]

MICROBOX



CERTIFICATE OF OCCUPANCY OR USE

Pursuant to Part V of the Building Ordinance 1972, the building consisting of;

*BRICK VENEER ADDITIONS
TO RESIDENCE*

situated at

Block <i>1</i>	Section <i>46</i>	Division <i>FRASER</i>
or situated at		

is considered to be substantially in accordance with the prescribed requirements for occupancy and use, subject to the endorsements listed below .

Approved plan Nos. <i>39256/E & 39256/F</i>		
Type of construction * <i>II</i>	Class of occupancy * <i>I</i>	(* as defined in the Building Manual A.C.T.)
Permit No. <i>31849</i>	Name of permit holder <i>C. BURKE</i>	

Endorsements

.....

.....

.....

.....

.....

.....

.....

.....

.....

.....

The issue of this Certificate does not affect the liability of a person to comply with the provisions of a law of the Territory (including the Building Ordinance) relating to the building work nor does it authorise the use of the land contrary to a provision, covenant or condition of lease .

26775

[Signature] *28/2/83*
Deputy Building Controller date

SEE OVERLEAF

"FULL SPECIFICATIONS WILL BE REQUIRED TO BE SUBMITTED IF PERMIT IS APPLIED FOR BY OWNER-BUILDER".

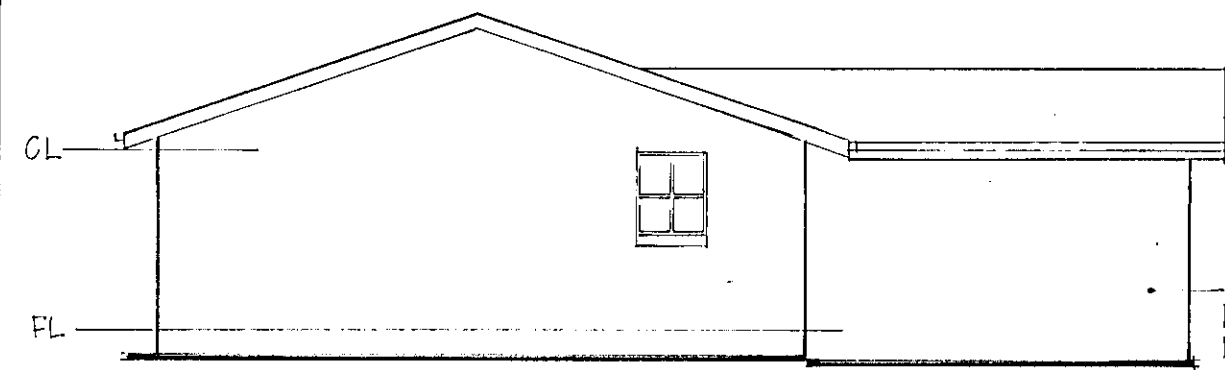

SIDE ELEVATION C

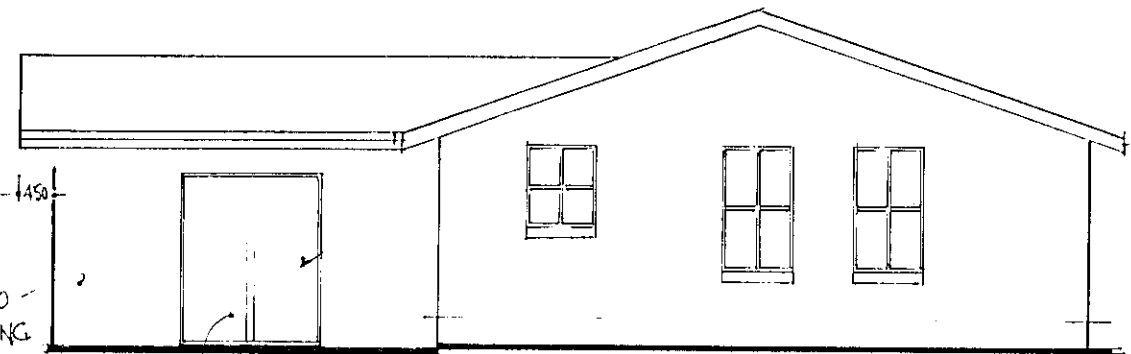

SIDE ELEVATION A

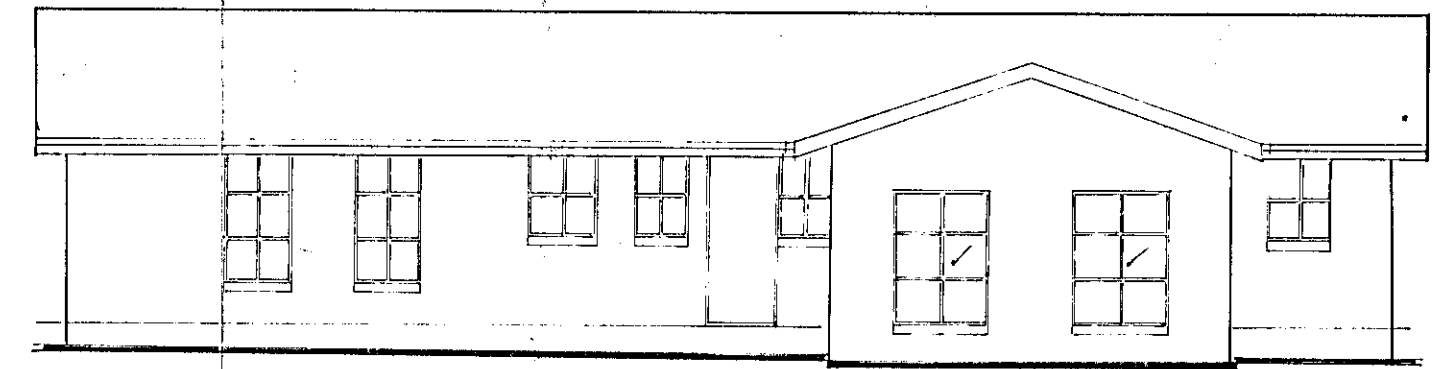

REAR ELEVATION

PLANS/FILE No. 39256
 Received Building Section
 29 OCT 1980
 Dept. of the Capital Territory

AMENDMENT (1) CHANGE FROM FLAT ROOF TO GABLE PITCH ROOF.

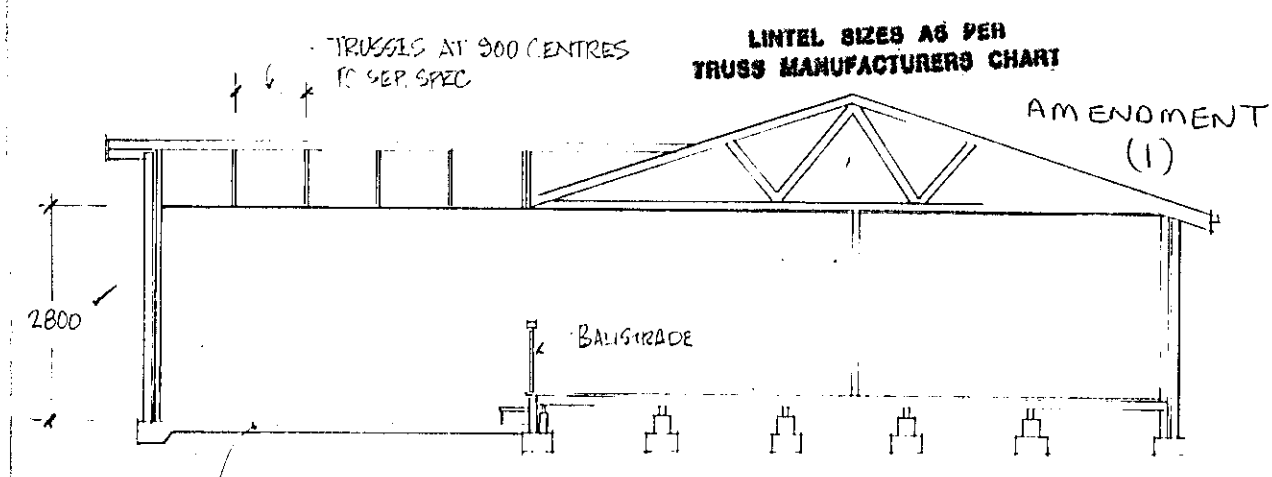

SECTION 'AA'

DEPTH OF FILL UNDER SLAB NOT TO EXCEED 400 mm
 FOOTINGS TO BE TAKEN DOWN TO SOLID GROUND

ALL WORK SHALL BE CONDUCTED IN ACCORDANCE WITH THE BUILDING ACT, THE BUILDING REGULATIONS ON THE PLANS AND ANY NOTICES SPECIFIED ON THE BUILDING PERMIT. THE APPROVAL OF PLANS OR THE GRANT OF A BUILDING PERMIT DOES NOT AFFECT THE OPERATION OF ANY OTHER LAW IN THE TERRITORY, NOR DOES IT AUTHORISE THE USE OF THE LAI... CONTRARY TO A PROVISION, COVENANT OR CONDITION OF LEASE.

"NO SURVEY CERTIFICATE REQUIRED."
 LESSEE/BUILDER RESPONSIBLE FOR CORRECT SITING

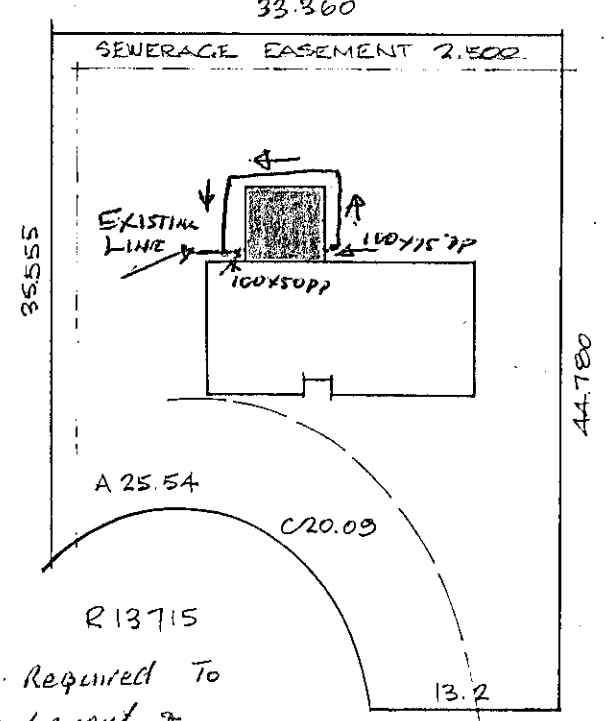

SITE PLAN
 SCALE 1:500

NOTE
 PROVIDE STUD UNDER EACH TRUSS

- NOTES:
1. STEEL WALL INTERNAL FRAMING, HEAD BEAMS AND BRACING, TO BE IN ACCORDANCE WITH DURAFRAME SPECIFICATION ATTACHED TO THIS PLAN
 2. CYPRESS CEILING AND WALL LINING IN ACCORDANCE WITH DURAFRAME SPECIFICATION
 3. EXTERNAL WALLS OF BRICK TO MATCH EXISTING RESIDENCE
 4. WIDTH OF STEP DOWN 1 METRE, TREAD 280 RISERS 200 190 MAX.
 5. TRUSSES TO SEPARATE SPEC ATTACHED TO PLAN
 6. THIS PLAN TO BE READ IN CONJUNCTION WITH APPROVED PLAN 39256
 7. ALL DIMENSIONS TO BE CHECKED ON SITE BY BUILDER PRIOR TO COMMENCEMENT OF WORK.

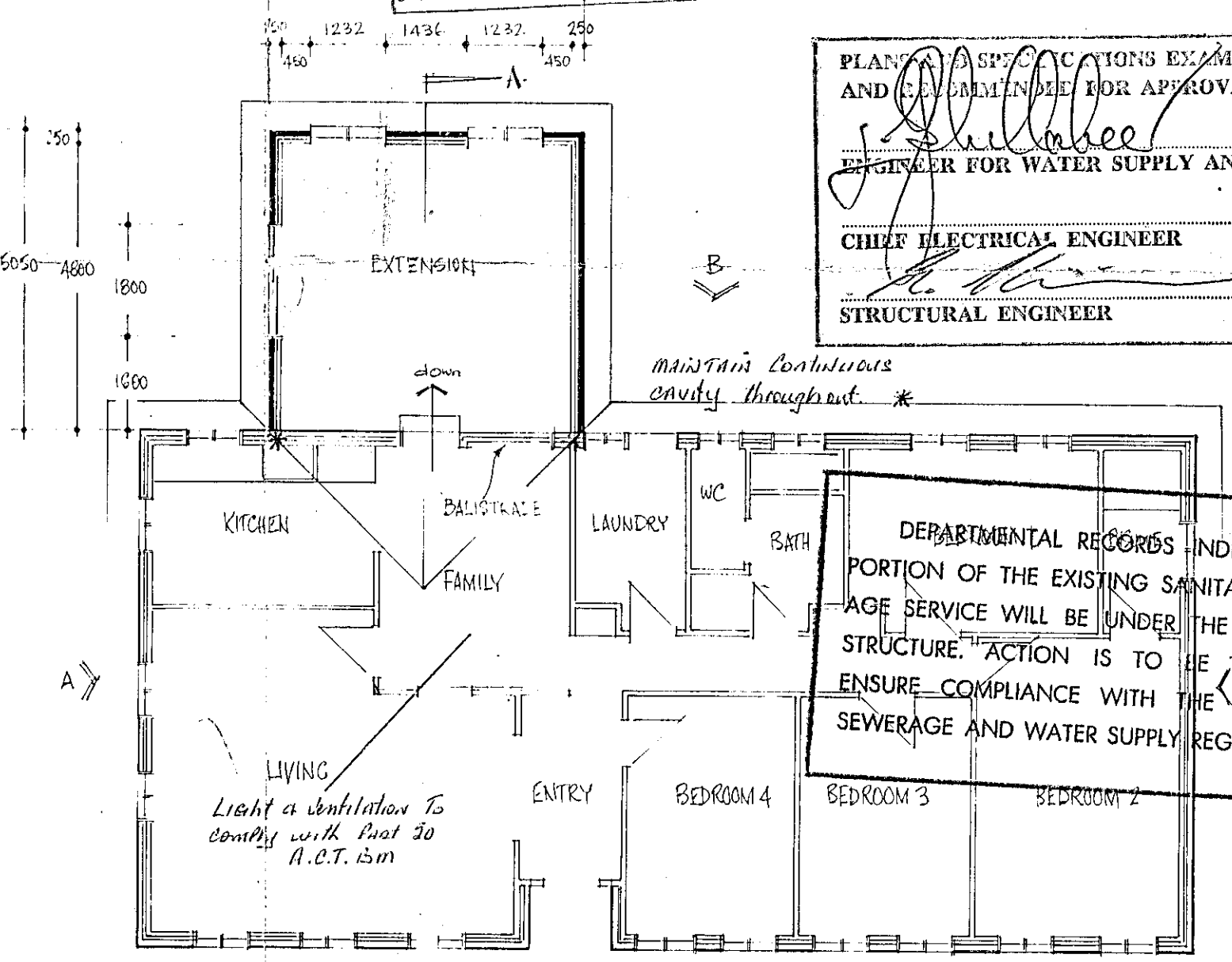

PLAN

DEPARTMENTAL RECORDS INDICATE THAT PORTION OF THE EXISTING SANITARY DRAINAGE SERVICE WILL BE UNDER THE PROPOSED STRUCTURE. ACTION IS TO BE TAKEN TO ENSURE COMPLIANCE WITH THE CANBERRA SEWERAGE AND WATER SUPPLY REGULATIONS.

APPROVED FOR CONSTRUCTION BY THE HOLDER OF A CLASS "C" LICENCE.
 CLASS OF OCCUPANCY: RESIDENCE I
 OUTBUILDINGS X
 12 NOV 1980
 DEPUTY BUILDING CONTROLLER

BUILDINGS (DESIGN AND SITING) ORDINANCE 1964 AS AMENDED
 APPROVAL GRANTED
 12 NOV 1980
 DELEGATE
 NATIONAL CAPITAL DEVELOPMENT COMMISSION

SCALE	1:100 U.O.S.	PROPOSED EXTENSION FOR MR A & MRS M. J. BRETT.	BLOCK	1	FRASER ACT
			SECTION	46	

Peuren Agencies Pty. Limited

1 of 2

Manufacturers' Distributors
P.O. Box 22, Mawson A.C.T. 2607

PLANS/FILE No. 22-56
Received Building Section
20 MAY 1981
Dept. of the Capital Territory

INSTALLATION OF CAST IRON STOVES.

Check that your Flue Kit is complete. You should have 2 6' lengths of inner flue, ~~one~~ ^{2 x 3/4} length of outer flue (galv.), one joiner (socket), one ceiling ceil, one bag of insulation, one double cowl and one tin of boiler cement.

Some stoves require a conversion piece and/or a damper (extras). Unpack your Stove and assemble it in the correct position, making sure you are the correct distance from the nearest wall, I.E. 8" from a non combustable wall and 14" from a combustable wall. Drop a plumb line from the ceiling to the centre of the flue outlet. Mark this point on the ceiling. Before cutting any holes check the position of any beams in the ceiling that may interfere with the flue. If there are no obstructions; mark with a compass, a circle the same size as the outer ring of the ceiling ceil on the ceiling, and using a key hole saw to remove the section. If necessary use a rasp or file to enlarge the hole so as the ceil fits snugly. Remove ceil, centre the plumb in the hole and mark or remove necessary tiles or metal roof for the rest of the outer flue. If your stove has a conversion piece, cement it to the Stove (do not screw or rivet to stove). Place joiner in lower half of flue and rivet. Then place flue on top of conversion piece or Stove outlet. Mark the flue at ceiling level and then remove. Cut a nick in the ceiling ceil, about 30mm x 5mm, along the circumference of the inner circle (see diagram). Then screw ceil down to about 25mm to 50mm below the ceiling line marked on flue. Push flue up into hole. Position ceil and then rotate flue down onto conversion piece until a tight fit is formed. Fix ceil to batons in ceiling. Then place upper flue on to joiner and pop rivet. Place outer flue over inner flue and make sure it is firmly on ceiling ceil. Trim flue so as the inner flue extends about 80mm above the outer. Pack insulation down the sides of the flue and compress with a long piece of timber. Then place double cowl on flue and rivet.

We can supply you with a dektite flashing if you wish to do it yourself. This is for tile and iron roofs or you can have a Plumber flash the roof for you. Detail upon purchase.

Note... All installations must conform with your local building authority. If in doubt check as this code varies from area to area. This is an insulated type flue and we believe the best of its kind.

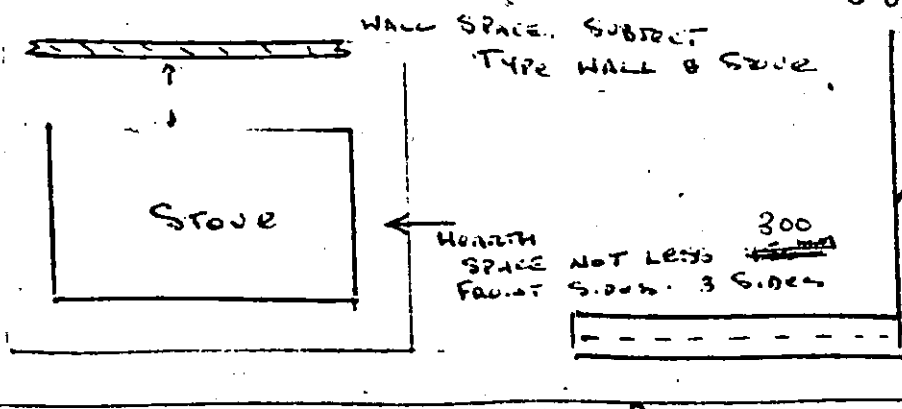
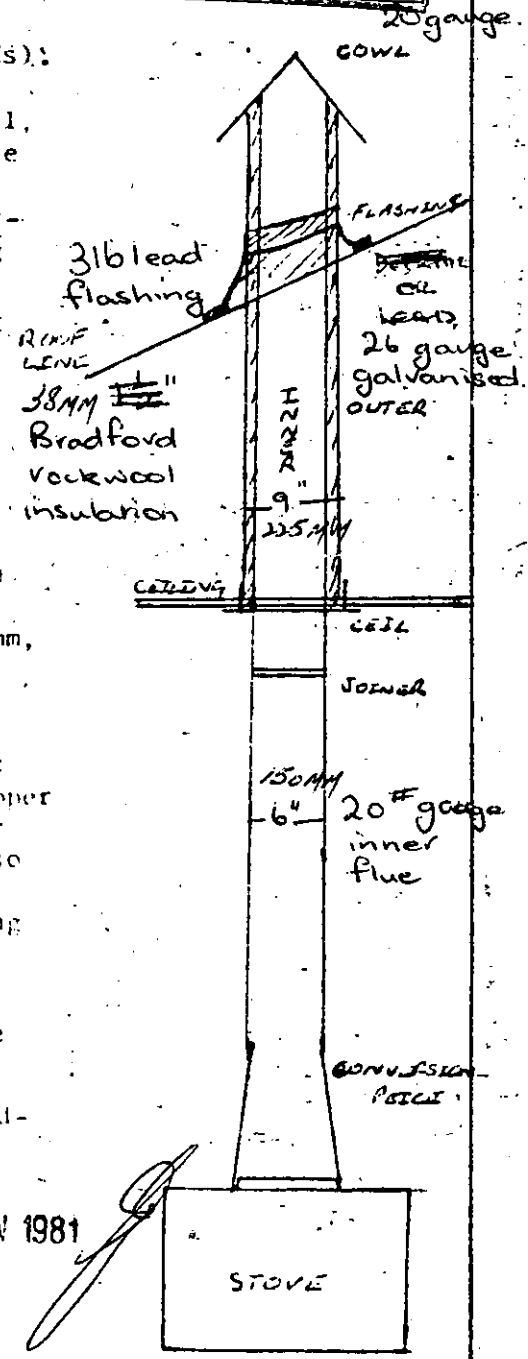

5 JUN 1981

REF LOCAL GOVT ACT, DOC NO 1021 A.

INSTALLATION TO COMPLY WITH PARTS OF THE BUILDING MANUAL ACT.



CERTIFICATE OF OCCUPANCY OR USE

Pursuant to Part V of the Building Ordinance 1972, the building consisting of:

Fireplace and Pergola

situated at

Block <i>1</i>	Section <i>46</i>	Division <i>Fraser</i>
or situated at		

is considered to be substantially in accordance with the prescribed requirements for occupancy and use, subject to the endorsements listed below.

Approved plan Nos. <i>39256/9</i>		
Type of construction * <i>5</i>	Class of occupancy * <i>1</i>	(* as defined in the Building Manual A.C.T.)
Permit No. <i>76226</i>	Name of permit holder <i>M. Brett.</i>	

Endorsements

BUILDING WORK EXISTING PRIOR TO APPROVAL UNDER BUILDING ORDINANCE 1972. NO INSPECTIONS CARRIED OUT DURING CONSTRUCTION UNDER S.35.

The issue of this Certificate does not affect the liability of a person to comply with the provisions of a law of the Territory (including the Building Ordinance) relating to the building work nor does it authorise the use of the land contrary to a provision, covenant or condition of lease.

47268

[Signature]
Deputy Building Controller

5.8.85
date

SEE OVERLEAF



ACT Building, Electrical and Plumbing Control

GPO Box 1908, Canberra ACT 2601

Certificate of Occupancy and Use

Certificate No. 01266N1C1

This Certificate is issued in accordance with Section 53 (3) of the Building Act 1972.

The building work listed on this certificate has been completed substantially in accordance with the prescribed requirements and is considered fit for occupation and use.

Builder GEOFFREY STARKEY	Site for Project Address 34 CARRODUS STREET
Notice of Intention to Start Work Nu 01266N1	Suburb Section Block FRASER 46 1
	Plan 01266/A

Building Work

Nature of Work	Project Item Description	Unit	Other Description	Class of Occupancy	Type of Construction
ADDITIONS TO	RESIDENCE		& GARAGE	1a(i) & 10	NA

Comments

[Empty comment box]

Important note:

1. Residential building statutory warranties and residential insurance apply in relation to building work.
2. The issue, under this Part, of a certificate in respect of a building or portion of a building does not affect the liability of a person to comply with the provisions of a law of the Territory (including this Act) relating to the building or portion of the building.

TED MILNE
Deputy Building Controller

6/7/2001
Date

BUILDING APPROVAL.
 BUILDING APPROVAL, OR PART THEREOF
 ISSUED UNDER s34 OF THE BUILDING
 ACT 1973, IS ON A SEPERATE DOCUMENT.

Giuseppe Gioffre 31 JAN 2001
 GIUSEPPE GIOFFRE DATE

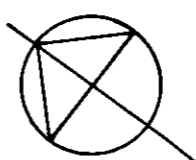

Plan No: 01266/A
 - 1 FEB 2001
 Received BEPCON
 Planning and Land Management

LAND (PLANNING AND ENVIRONMENT)
 ACT 1991
 APPROVAL GRANTED
 PURSUANT TO SECTION 230 OR 245
 10 NOV 2000
 Delegate of the Minister

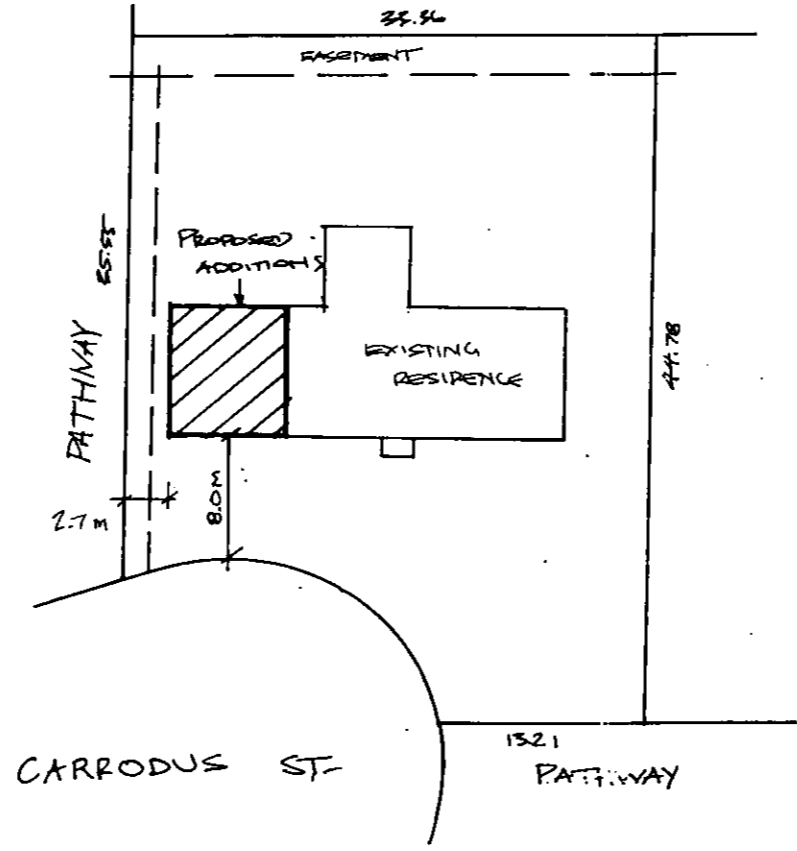

CONNECT ALL NEW CU TO
 EXIST SW LINES.

DIMENSIONS TO BE CONFIRMED
 ON SITE PRIOR TO CONSTRUCTION

SW+ SWGE TIE NOT AVAILABLE
 AT TIME OF DRAFTING.

CONTOURS NOT AVAILABLE AT
 TIME OF DRAFTING.

Application No. 2000 6466

NOTE: ALL PLANS AND STRUCTURAL INDICATIONS ARE INDICATIVE ONLY AND ARE TO BE CHECKED
 AND APPROVED BY APPROPRIATE PERSONS AND ARE TO BE USED ONLY AS A GUIDE FOR THE DESIGN
 OF THE STRUCTURAL REQUIREMENTS FOR THIS STRUCTURE.

NOTE: ALTHOUGH CARE IS TAKEN URBAN DESIGN DOES NOT ACCEPT
 RESPONSIBILITY FOR ERRORS THAT ARE THE RESULT OF INCORRECT
 INFORMATION SUPPLIED TO URBAN DESIGN.

NOTES:
 - ALL DIMENSIONS AND NOTES ARE TO BE CONFIRMED BY
 BUILDER AND / OR OWNER BEFORE COMMENCING WORKS.
 - DO NOT SCALE OFF DRAWINGS. USE STATED NOTES AND
 DIMENSIONS ONLY.
 - ALL CONSTRUCTION WORK IS TO BE DONE IN ACCORDANCE
 WITH THE BUILDING CODE OF AUSTRALIA AND ALL RELEVANT
 CODES AND GOVERNING BODIES.
 - TIMBER FRAMING IS TO BE COMPLETED IN ACCORDANCE WITH
 THE NATIONAL LIGHT TIMBER FRAMING CODE S.A.A. 1984.
 - CONCRETE SLABS AND FOOTINGS ARE TO BE IN ACCORDANCE
 WITH S.A.A. 2570.1.
 - ANY DISCREPANCIES FOUND WITH THESE DRAWINGS MUST BE
 REPORTED TO URBAN DESIGN AND DRAFTING BEFORE WORKS
 BEGIN.
 - ALL NATURAL GROUND LINES, SITE CUTS, INDICATED LEVELS,
 DRIVEWAYS, LIGHTPOLES AND ALL OTHER GRAPHICALLY
 REPRESENTED SYMBOLS ARE INDICATIVE ONLY AND MUST BE
 VERIFIED ON SITE BY THE BUILDER AND PROFESSIONAL APPLICABLE
 BEFORE WORKS BEGIN.

URBAN
 DESIGN

SHAPE
 .
 DEFINITION
 .
 FORM

COPYRIGHT ©
 URBAN DESIGN + DRAFTING
 56 STUART ST GRIFFITH ACT
 PO BOX 2484 MANUKA ACT 2608
 EMAIL URBANDESIGN@DI.COM.AU
 TEL/FAX 02 6260 7934
 MOBILE 0411 478 078

PROJECT
**Proposed
 Additions**

THIS DRAWING : SITE PLAN
 CLIENT
STUART + JULIE

BLOCK 1 JOB a2051

SECTION 46

SUBURB Frazer

DATE 16.10.00 DWG NO 1

SCALE 1:500 DRAWN Cad

AMENDMENTS

URBAN DESIGN OFFICE
 20 OCT 2000

COPYING OF THIS DRAWING IN PART AND / OR WHOLE IS IN
 BREACH OF COPYRIGHT LAW. COPYING WITH OUT PROPER
 AUTHORITY FROM URBAN DESIGN WILL RESULT IN LEGAL
 PROCEEDINGS BEING TAKEN AGAINST THOSE PARTIES INVOLVED.

COPYRIGHT URBAN DESIGN ©

Plan No: 01266/A
 - 1 FEB 2001
 Received B.F. CON
 Planning and Land Management

LAND (PLANNING AND ENVIRONMENT)
 ACT 1991
APPROVAL GRANTED
 PURSUANT TO SECTION 239 OR 245
 18 NOV 2000
 Delegate of the Minister

BUILDING APPROVAL.
 BUILDING APPROVAL, OR PART THEREOF
 ISSUED UNDER s34 OF THE BUILDING
 ACT 1972, IS ON A SEPERATE DOCUMENT.
 GIUSEPPE GIOFFRE DATE 27 JAN 2001

(A)

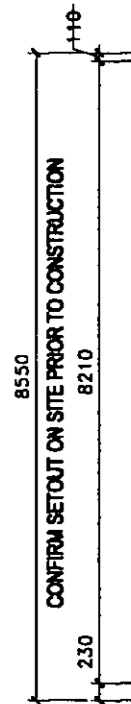
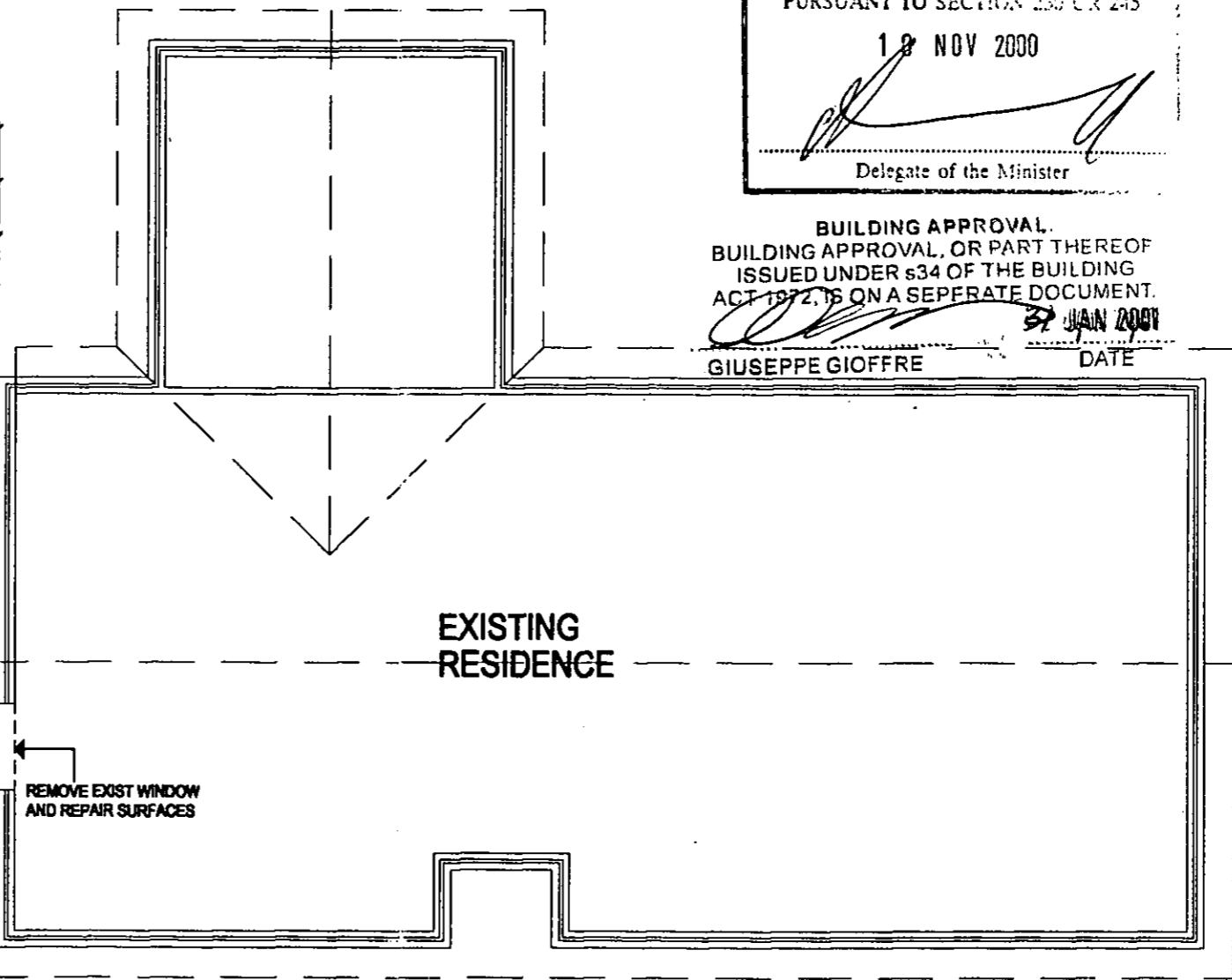
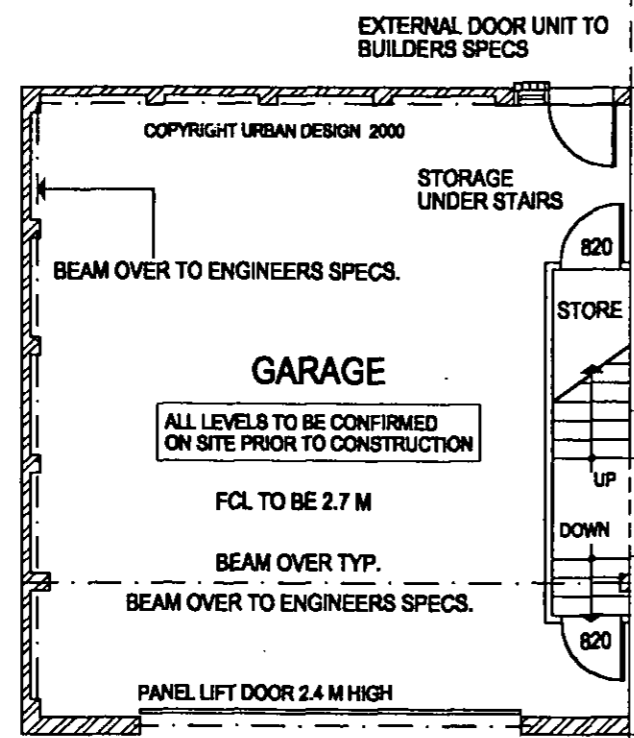
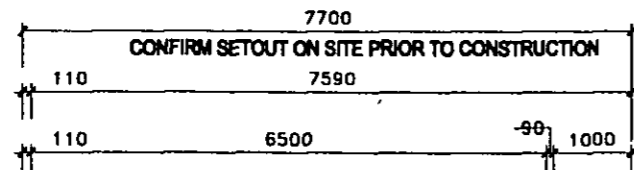

LOWER FLOOR PLAN
 GARAGE AREA - 65.84 SQM / 7.08 SQ
 INCLUDING STAIRS

(A)

NOTES:
 - ALL DIMENSIONS AND NOTES ARE TO BE CONFIRMED BY BUILDER AND / OR OWNER BEFORE COMMENCING WORKS.
 - DO NOT SCALE OFF DRAWINGS. USE STATED NOTES AND DIMENSIONS ONLY.
 - ALL CONSTRUCTION WORK IS TO BE DONE IN ACCORDANCE WITH THE BUILDING CODE OF AUSTRALIA AND ALL RELEVANT CODES AND GOVERNING BODIES.
 - TIMBER FRAMING IS TO BE COMPLETED IN ACCORDANCE WITH THE NATIONAL LIGHT TIMBER FRAMING CODE S.A.A. 1984.
 - CONCRETE SLABS AND FOOTINGS ARE TO BE IN ACCORDANCE WITH S.A.A. 2870.1.
 - ANY DISCREPANCIES FOUND WITH THESE DRAWINGS MUST BE REPORTED TO URBAN DESIGN AND DRAFTING BEFORE WORKS BEGIN.
 - ALL NATURAL GROUND LINES, SITE CUTS, INDICATED LEVELS, DRIVEWAYS, LIGHTPOLES AND ALL OTHER GRAPHICALLY REPRESENTED SYMBOLS ARE INDICATIVE ONLY AND MUST BE VERIFIED ON SITE BY THE BUILDER AND PROFESSIONAL APPLICABLE BEFORE WORKS BEGIN.

URBAN
 DESIGN

SHAPE
 .
 DEFINITION
 .
 FORM

COPYRIGHT ©
 URBAN DESIGN + DRAFTING
 10 STUART ST GRIFFITH ACT
 PO BOX 3484 MANUKA ACT 2602
 EMAIL: URBANDESIGN@AOL.COM.AU
 TEL/FAX 02 8280 7834
 MOBILE 0411 478 078

PROJECT
Proposed Additions

THIS DRAWING: LOWER FLOOR PLAN
 CLIENT
STUART + JULIE

BLOCK 1 JOB a2051

SECTION 46

SUBURB Frazer

DATE 16.10.00 DWG NO 2

SCALE 1:100 DRAWN Cad

AMENDMENTS

DESIGN & DRAFTING
 OFFICE
 20 OCT 2000

COPYING OF THIS DRAWING IN PART AND / OR WHOLE IS IN BREACH OF COPYRIGHT LAW. COPYING WITH OUT PROPER AUTHORITY FROM URBAN DESIGN WILL RESULT IN LEGAL PROCEEDINGS BEING TAKEN AGAINST THOSE PARTIES INVOLVED.
 COPYRIGHT URBAN DESIGN ©

Plan No: 01266/A
 - 1 FEB 2001
 Received [Signature]
 Planning and Environment

LAND (PLANNING AND ENVIRONMENT)
 ACT 1991
APPROVAL GRANTED
 PURSUANT TO SECTION 230 OR 245
 18 NOV 2000
 [Signature]
 Delegate of the Minister

BUILDING APPROVAL
 BUILDING APPROVAL, OR PART THEREOF
 ISSUED UNDER s34 OF THE BUILDING
 ACT 1972, IS ON A SEPERATE DOCUMENT.
 [Signature] 31 JAN 2001
 GIUSEPPE GIOFFRE DATE

NOTES:
 - ALL DIMENSIONS AND NOTES ARE TO BE CONFIRMED BY
 BUILDER AND / OR OWNER BEFORE COMMENCING WORKS.
 - DO NOT SCALE OFF DRAWINGS. USE STATED NOTES AND
 DIMENSIONS ONLY!
 - ALL CONSTRUCTION WORK IS TO BE DONE IN ACCORDANCE
 WITH THE BUILDING CODE OF AUSTRALIA AND ALL RELEVANT
 CODES AND GOVERNING BODIES.
 - TIMBER FRAMING IS TO BE COMPLETED IN ACCORDANCE WITH
 THE NATIONAL LIGHT TIMBER FRAMING CODE S.A.A. 1884.
 - CONCRETE SLABS AND FOOTINGS ARE TO BE IN ACCORDANCE
 WITH S.A.A. 2870.1.
 - ANY DISCREPANCIES FOUND WITH THESE DRAWINGS MUST BE
 REPORTED TO URBAN DESIGN AND DRAFTING BEFORE WORKS
 BEGIN.
 - ALL NATURAL GROUND LINES, SITE CUTS, INDICATED LEVELS,
 DRIVEWAYS, LIGHTPOLES AND ALL OTHER GRAPHICALLY
 REPRESENTED SYMBOLS ARE INDICATIVE ONLY AND MUST BE
 VERIFIED ON SITE BY THE BUILDER AND PROFESSIONAL APPLICABLE
 BEFORE WORKS BEGIN.

URBAN
 DESIGN

SHAPE
 .
 DEFINITION
 .
 FORM

COPYRIGHT ©
 URBAN DESIGN + DRAFTING
 50 STUART ST GRIFFITH ACT
 PO BOX 3484 MANUKA ACT 2603
 EMAIL URBANDESIGN@GMAIL.COM.AU
 TEL/FAX 02 6390 7934
 MOBILE 0411 478 078

PROJECT
**Proposed
 Additions**

THIS DRAWING : UPPER FLOOR PLAN
 CLIENT
STUART + JULIE

BLOCK 1 JOB a2051

SECTION 46

SUBURB Frazer

DATE 16.10.00 DWG NO 3

SCALE 1:100 DRAWN Cad

AMENDMENTS

DESIGN & SETTING
 OFFICE
 20 OCT 2000

COPYING OF THIS DRAWING IN PART AND / OR WHOLE IS IN
 BREACH OF COPYRIGHT LAW. COPYING WITH OUT PROPER
 AUTHORITY FROM URBAN DESIGN WILL RESULT IN LEGAL
 PROCEEDINGS BEING TAKEN AGAINST THOSE PARTIES INVOLVED.
 COPYRIGHT URBAN DESIGN ©

A

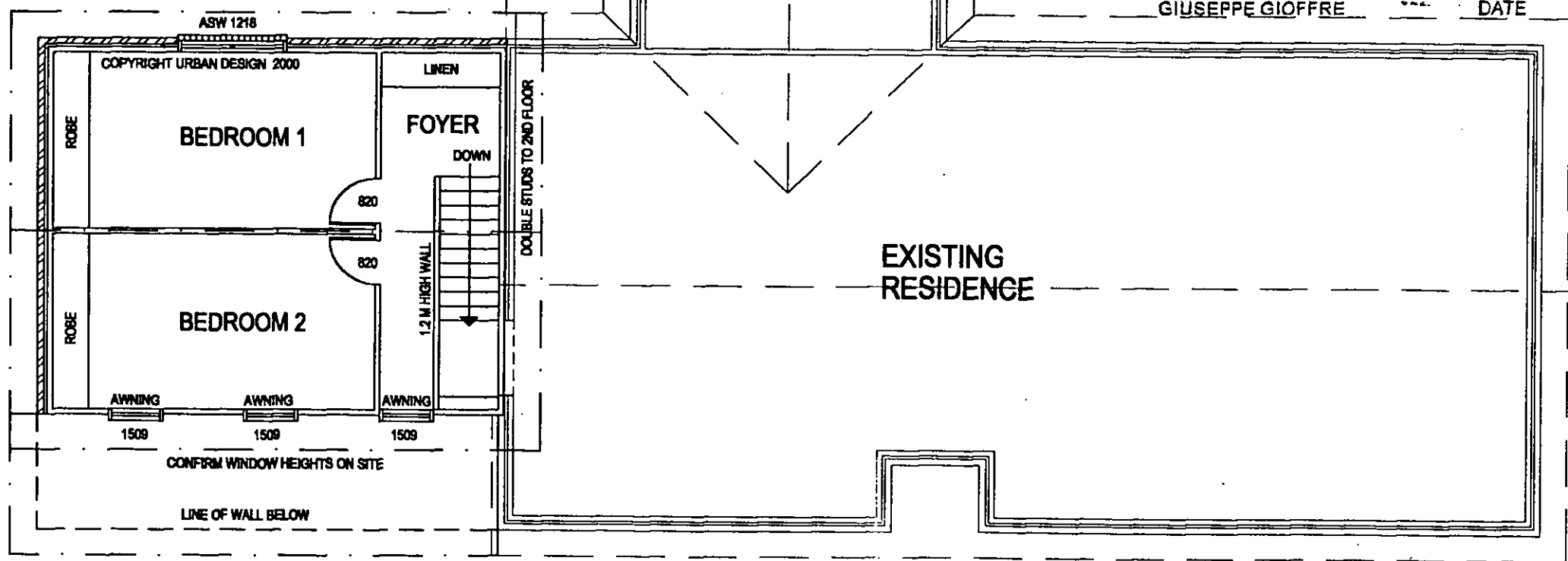
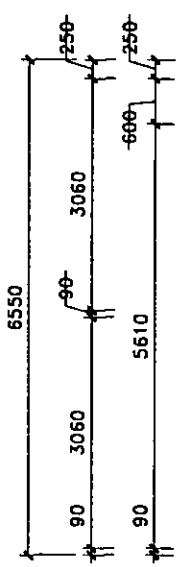
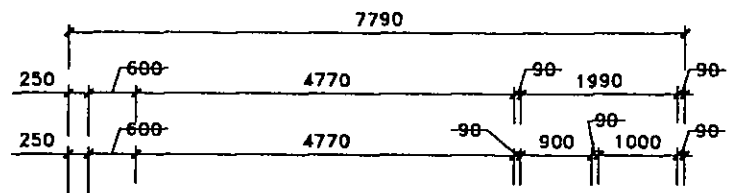

UPPER FLOOR PLAN
 AREA 51.0 SQM / 5.48 SQ
 INCLUDING STAIRS

A

Plan No: 01266/A
 - 1 FEB 2001
 Received by
 Planning and Development Management

LAND (PLANNING AND ENVIRONMENT) ACT 1991
APPROVAL GRANTED
 PURSUANT TO SECTION 230 OR 245
 10 NOV 2000
 Delegate of the Minister

CONC. ROOF TILES AS SELECTED
 PREFABRICATED ROOF TRUSSES AT 900CTRS MAX
 LINTEL SIZES AS PER TRUSS MANUF. CHARTS
 INSTALL TRUSSES AS PER TRUSS MANUFACTURERS SPECS.
 R3.0 CEILING INSULATION
 RI.5 WALL INSULATION

BUILDING APPROVAL
 BUILDING APPROVAL, OR PART THEREOF
 ISSUED UNDER s34 OF THE BUILDING
 ACT 1972, IS ON A SEPERATE DOCUMENT.
 31 JAN 2001
 GIUSEPPE GIOFFRE DATE

NOTES:
 - ALL DIMENSIONS AND NOTES ARE TO BE CONFIRMED BY BUILDER AND / OR OWNER BEFORE COMMENCING WORKS.
 - DO NOT SCALE OFF DRAWINGS. USE STATED NOTES AND DIMENSIONS ONLY.
 - ALL CONSTRUCTION WORK IS TO BE DONE IN ACCORDANCE WITH THE BUILDING CODE OF AUSTRALIA AND ALL RELEVANT CODES AND GOVERNING BODIES.
 - TIMBER FRAMING IS TO BE COMPLETED IN ACCORDANCE WITH THE NATIONAL LIGHT TIMBER FRAMING CODE S.A.A. 1984.
 - CONCRETE SLABS AND FOOTINGS ARE TO BE IN ACCORDANCE WITH S.A.A. 2870.1.
 - ANY DISCREPANCIES FOUND WITH THESE DRAWINGS MUST BE REPORTED TO URBAN DESIGN AND DRAFTING BEFORE WORKS BEGIN.
 ALL NATURAL GROUND LINES, SITE CUTS, INDICATED LEVELS, DRIVEWAYS, LIGHTPOLES AND ALL OTHER GRAPHICALLY REPRESENTED SYMBOLS ARE INDICATIVE ONLY AND MUST BE VERIFIED ON SITE BY THE BUILDER AND PROFESSIONAL APPLICABLE BEFORE WORKS BEGIN.

URBAN
 DESIGN

SHAPE
 DEFINITION
 FORM

COPYRIGHT ©
 URBAN DESIGN + DRAFTING
 50 STUART ST GRIFFITH ACT
 PO BOX 3484 MANUKA ACT 2803
 EMAIL: URBANDESIGN@ADL.COM.AU
 TEL/FAX 02 8290 7934
 MOBILE 0411 478 078

PROJECT
Proposed Additions

THIS DRAWING: ELEVATIONS
 CLIENT
STUART + JULIE

BLOCK 1 JOB a2051

SECTION 46

SUBURB **Frazer**

DATE 16.10.00 DWG NO 4

SCALE 1:100 DRAWN Cad

AMENDMENTS

URBAN DESIGN
 OFFICE
 20 OCT 2000

COPYING OF THIS DRAWING IN PART AND / OR WHOLE IS IN BREACH OF COPYRIGHT LAW. COPYING WITH OUT PROPER AUTHORITY FROM URBAN DESIGN WILL RESULT IN LEGAL PROCEEDINGS BEING TAKEN AGAINST THOSE PARTIES INVOLVED.
 COPYRIGHT URBAN DESIGN ©

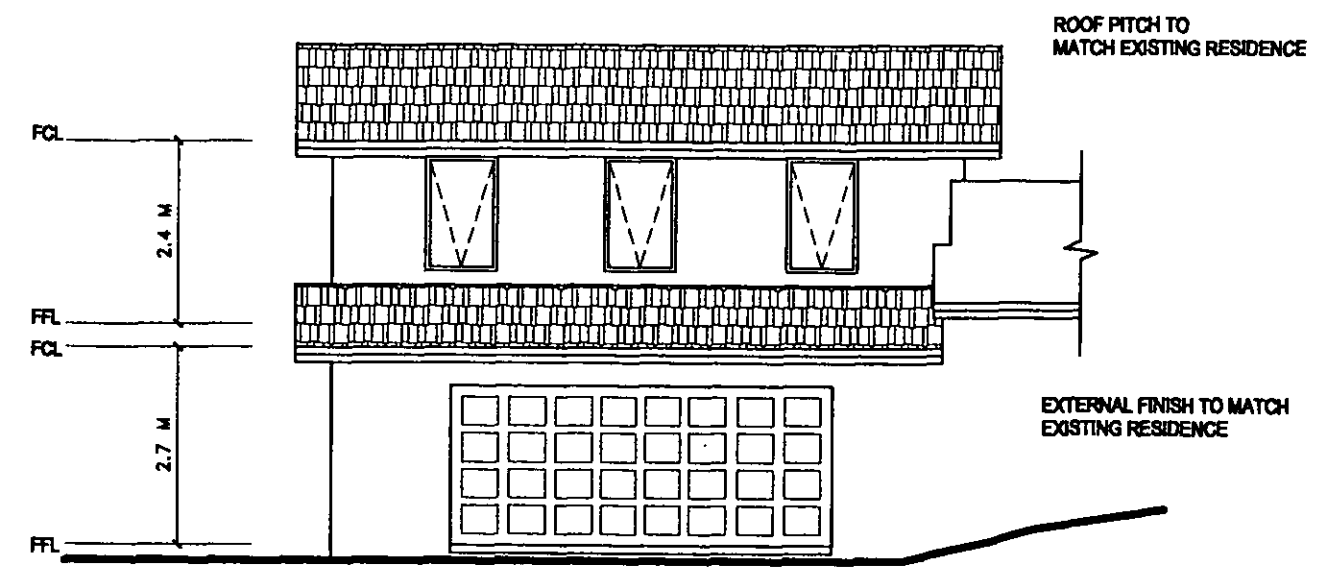

SOUTH WEST ELEVATION

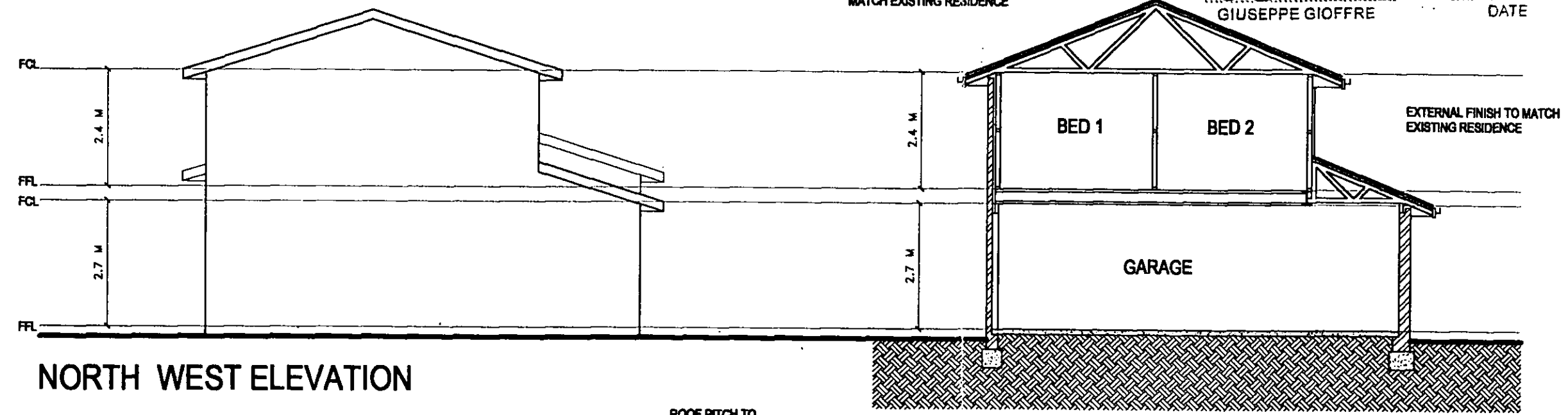

NORTH WEST ELEVATION

SECTION A-A

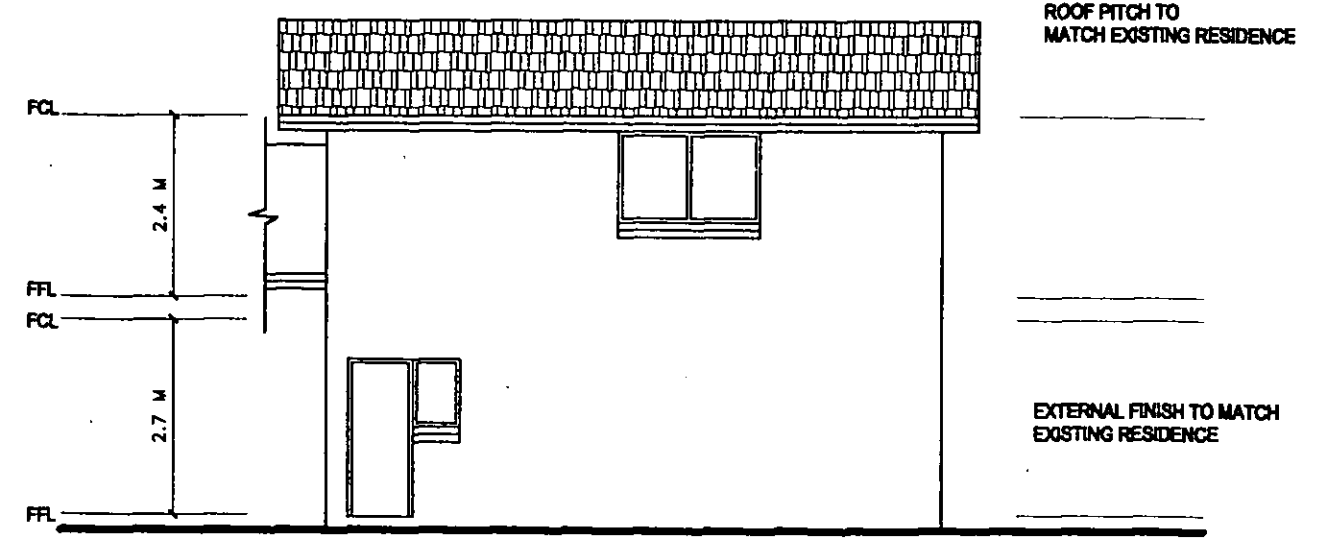

NORTH EAST ELEVATION

ALL CONCRETE FOOTINGS AND SLABS TO BE IN ACCORDANCE WITH S.A.A. CODE 2870.1
 PROVIDE CONTINUOUS DAMPPROOF MEMBRANE UNDER SLAB.

90x35 PINE PLATES AND NOGGINGS
 90x45 PINE STUDS AT 450CTRS TO LOAD BEARING WALLS AND AT 600CTRS TO NON-LOAD BEARING WALLS
 PLASTERBOARD INTERNAL WALL AND CEILING LINING
 CEMENT SHEET LINING TO WET AREAS



Certificate of Occupancy and Use

Certificate No.: **B2022264C1**

Access Canberra Land, Planning and Building Services

ABN 16 479 763 216
8 Darling Street Mitchell
GPO Box 158 ACT 2601
www.act.gov.au/accesscbr

This Certificate is issued in accordance with Section 69 (2) of the Building Act 2004.

The building work listed on this certificate has been completed substantially in accordance with the prescribed requirements and is considered fit for occupation and use.

Unit	Block	Section	Division (Suburb)	District	Jurisdiction
	1	46	FRASER	BELCONNEN	Australian Capital Territory

Plans
B2022264/A

Building Works

Class of Occupancy	Nature of Work	Project Item Description	Other Description	Type Of Const.	Unit	BCN ID	Builder
1a	Alterations	DA EXEMPT-RESIDENCE	Existing Roof Cladding Change	NA		B2022264N1	DEAN ANTHONY CROWE
1a	Alterations	DA EXEMPT-RESIDENCE	Existing Window Installations	NA		B2022264N1	DEAN ANTHONY CROWE
10a	Additions	DA EXEMPT-PERGOLA	Existing Covered Alfresco	NA		B2022264N1	DEAN ANTHONY CROWE
10a	Additions	DA EXEMPT-PERGOLA	Existing Covered Pergola	NA		B2022264N1	DEAN ANTHONY CROWE

Comments

Important Note:

The issue, under this Part, of a certificate in respect of a building or portion of a building does not affect the liability of a person to comply with the provisions of a law of the territory (including this Act) relating to the building or portion of the building.

Issued by: Rebecca Rattenbury
Delegate of the ACT Construction
Occupations Registrar.

Issued on: 31/01/2022

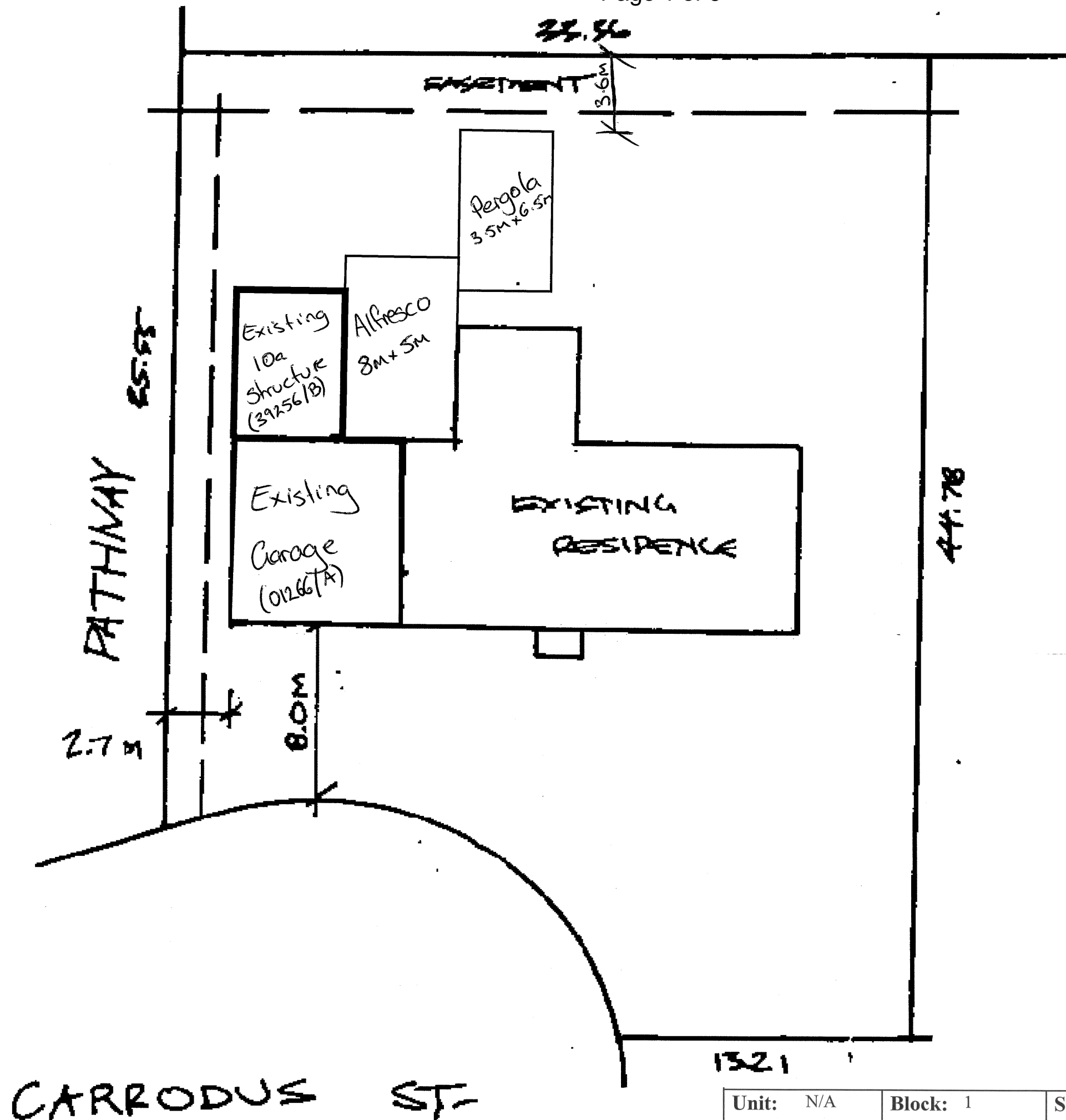

APPROVAL DATE
27/01/2022

CAPITAL CERTIFIERS P/L
ACN 158 851 239

BUILDING APPROVAL
issued under the s.28 of the
Building Act 2004.
CAPITAL CERTIFIERS
PTY LTD
COLA LIC. 2012 818
ACN: 158 851 239

SLH

Unit: N/A	Block: 1	Section: 46	Suburb: Fraser - ACT
Address: 34 Carrodus Street			
Owner Details: Paul & Kathleen Carnell			Mobile: 0433 883 190

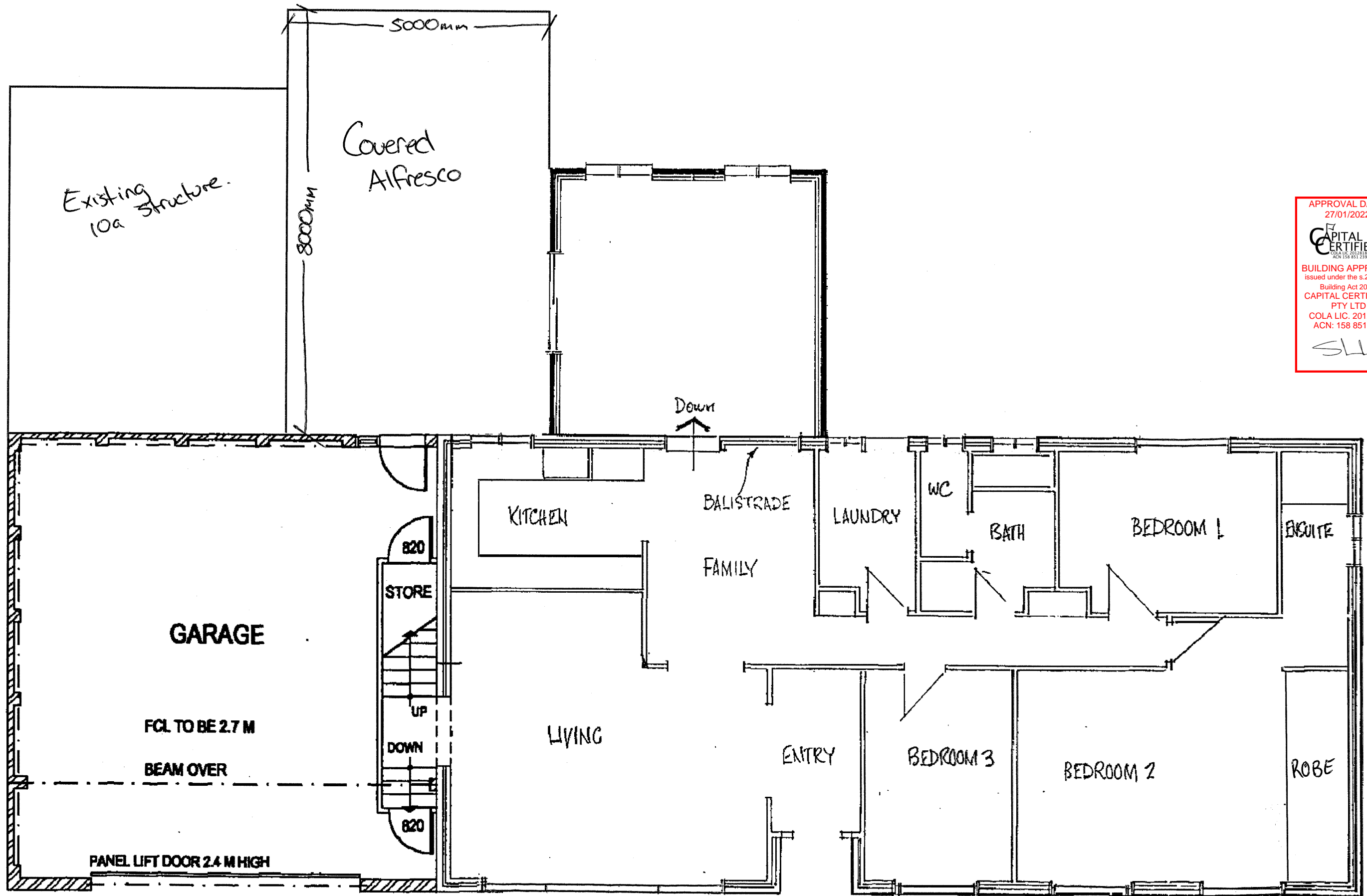

APPROVAL DATE
27/01/2022

CAPITAL CERTIFIERS P/L
ACN 158 851 239

BUILDING APPROVAL
issued under the s.28 of the
Building Act 2004.
CAPITAL CERTIFIERS
PTY LTD
COLA LIC. 2012 818
ACN: 158 851 239

SLL

Unit: N/A	Block: 1	Section: 46	Suburb: Fraser - ACT
Address: 34 Carrodus Street			
Owner Details: Paul & Kathleen Carnell			Mobile: 0433 883 190

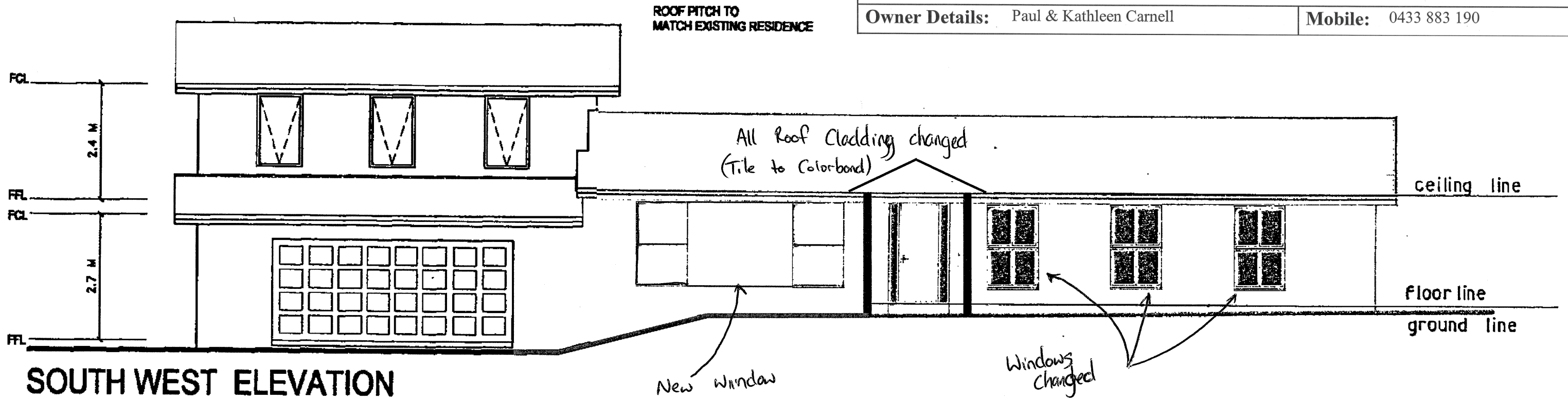

SOUTH WEST ELEVATION

APPROVAL DATE
27/01/2022

CAPITAL CERTIFIERS PTY LTD
COLA LIC. 2012 818
ACN: 158 851 239

SLC



NORTH EAST ELEVATION

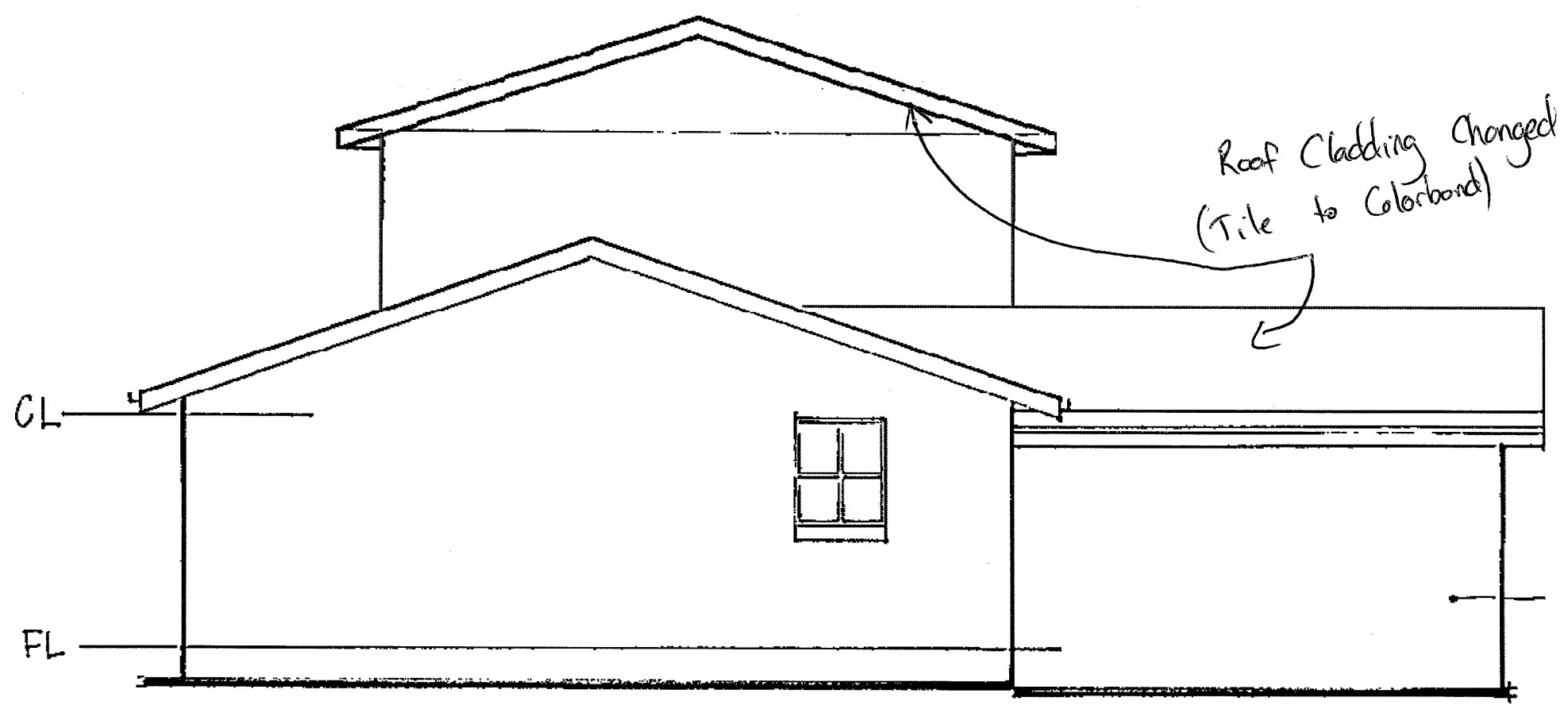
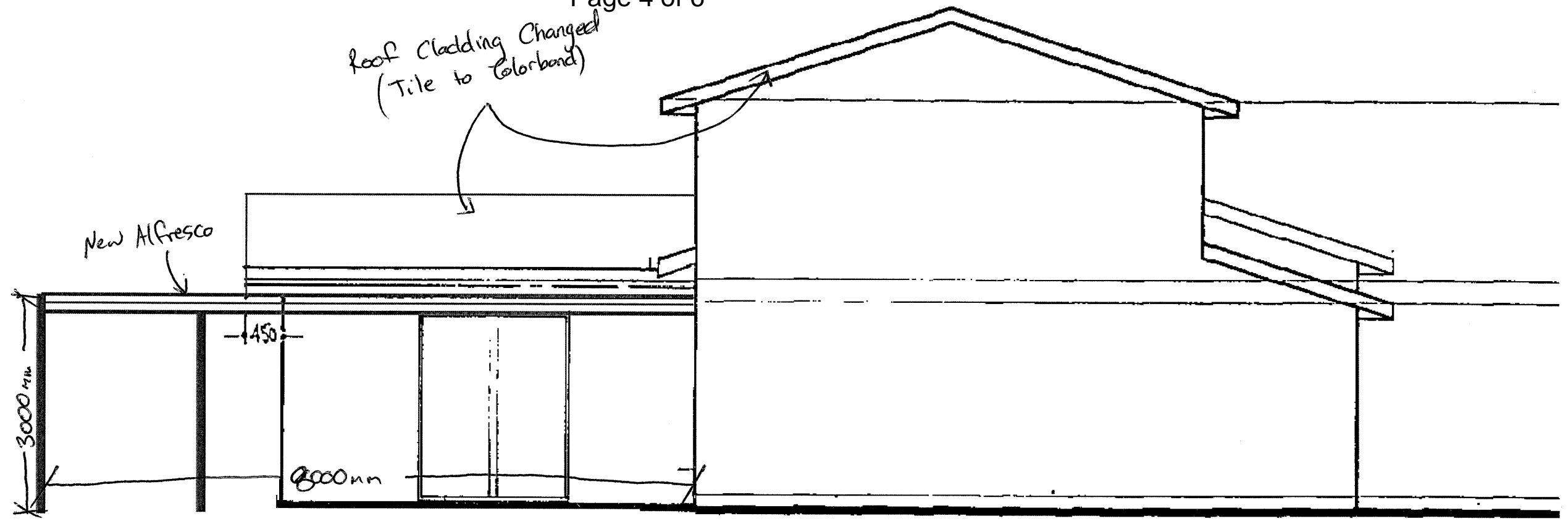

SIDE ELEVATION C

APPROVAL DATE
27/01/2022

CAPITAL CERTIFIERS P/L
ACN 158 851 239

BUILDING APPROVAL
issued under the s.28 of the
Building Act 2004.
CAPITAL CERTIFIERS
PTY LTD
COLA LIC. 2012 818
ACN: 158 851 239

SLH

Unit: N/A	Block: 1	Section: 46	Suburb: Fraser - ACT
Address: 34 Carrodus Street			
Owner Details: Paul & Kathleen Carnell			Mobile: 0433 883 190

Existing Stand Alone Pergola

Fraser : Block - 1
Section - 46 .

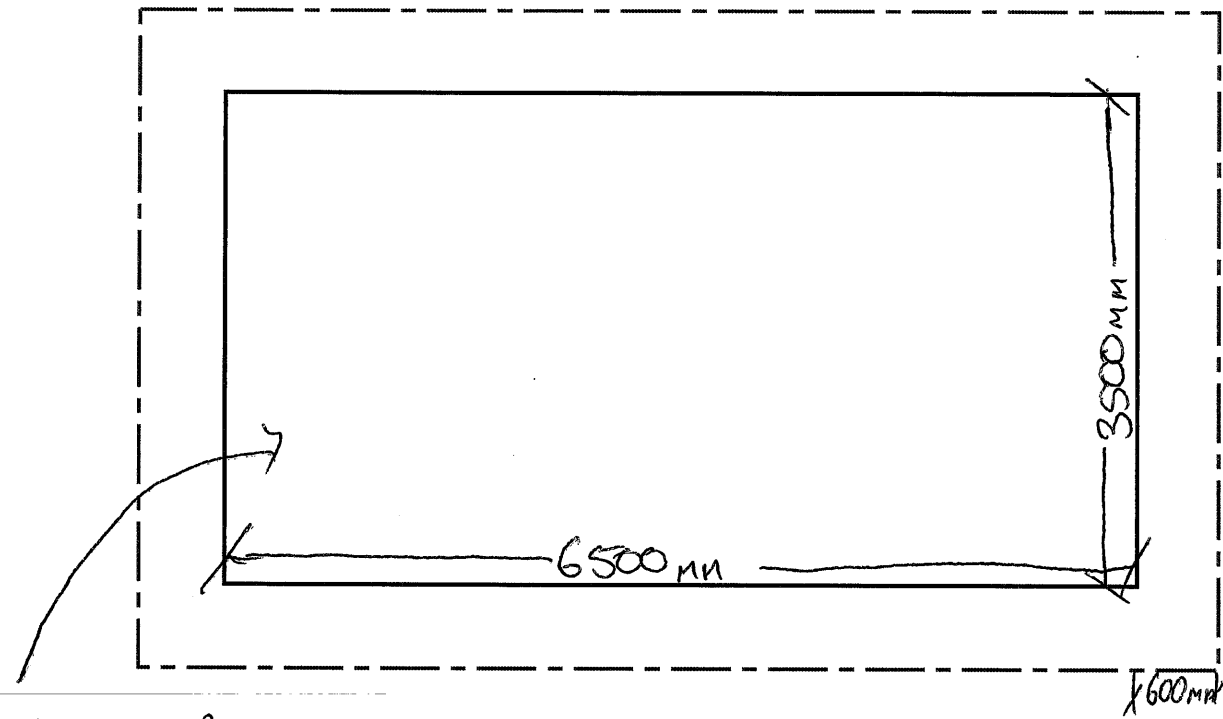

All Framing as per
AS 1684.

APPROVAL DATE
27/01/2022
CAPITAL CERTIFIERS P/L
COLA LIC. 2012 818
ACN: 158 851 239
BUILDING APPROVAL
issued under the s.28 of the
Building Act 2004.
CAPITAL CERTIFIERS
PTY LTD
COLA LIC. 2012 818
ACN: 158 851 239
SLL

Unit: N/A	Block: 1	Section: 46	Suburb: Fraser - ACT
Address: 34 Carrodus Street			
Owner Details: Paul & Kathleen Carnell			Mobile: 0433 883 190

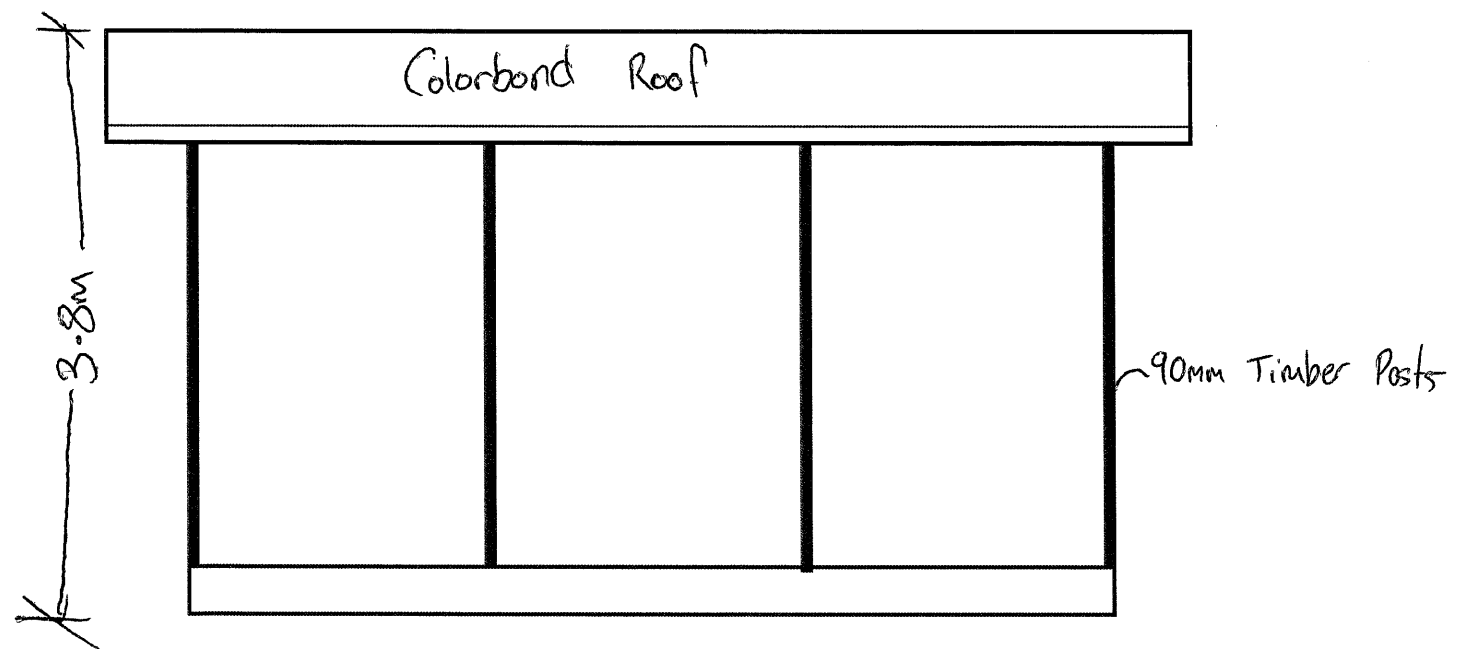
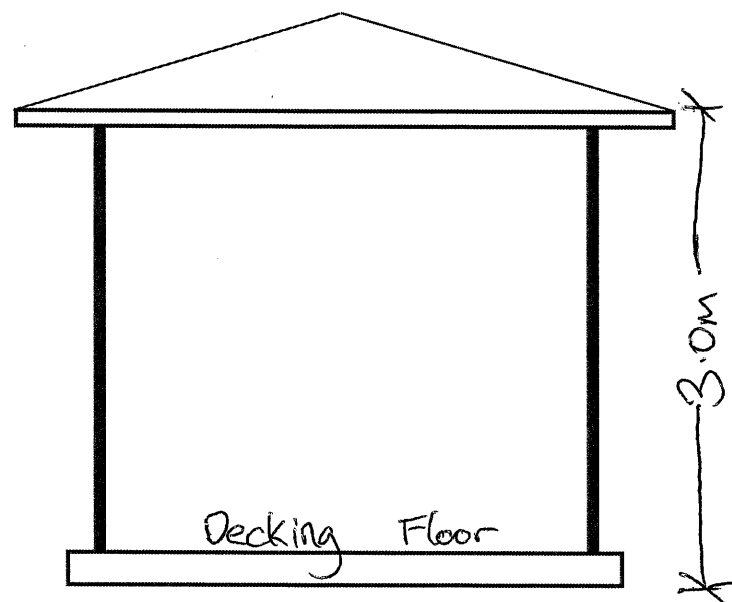

Existing Stand Alone Pergola

Fraser : Block - 1
Section - 46 .

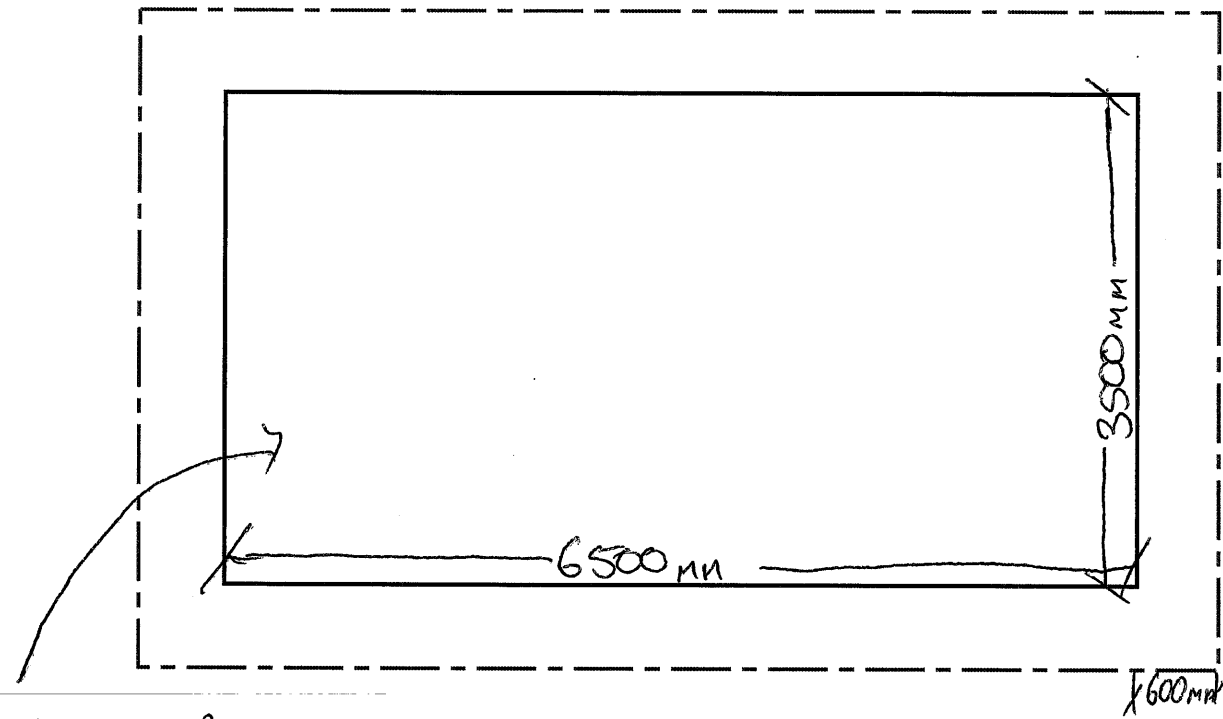

All Framing as per
AS 1684.

APPROVAL DATE
27/01/2022
CAPITAL CERTIFIERS P/L
COLA LIC. 2012 818
ACN: 158 851 239
BUILDING APPROVAL
issued under the s.28 of the
Building Act 2004.
CAPITAL CERTIFIERS
PTY LTD
COLA LIC. 2012 818
ACN: 158 851 239
SLL

Unit: N/A	Block: 1	Section: 46	Suburb: Fraser - ACT
Address: 34 Carrodus Street			
Owner Details: Paul & Kathleen Carnell			Mobile: 0433 883 190

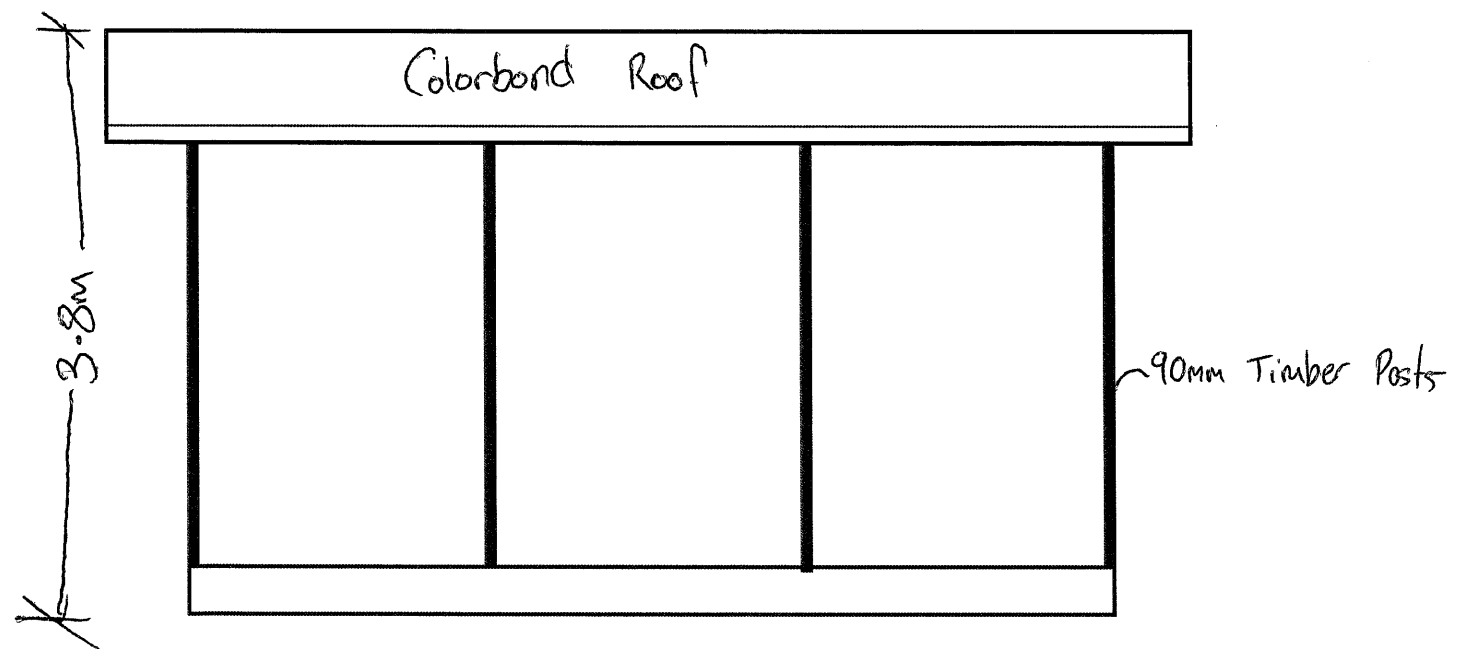
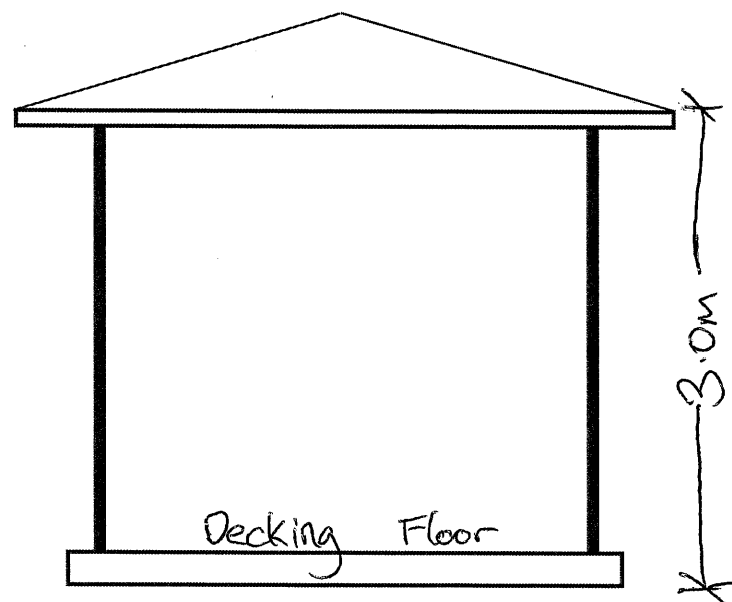



Certificate of Occupancy and Use

Certificate No.: **B20225225C1**

**Access Canberra Land, Planning and
Building Services**

ABN 16 479 763 216
8 Darling Street Mitchell
GPO Box 158 ACT 2601
www.act.gov.au/accesscbr

This Certificate is issued in accordance with Section 69 (2) of the Building Act 2004.

The building work listed on this certificate has been completed substantially in accordance with the prescribed requirements and is considered fit for occupation and use.

Unit	Block	Section	Division (Suburb)	District	Jurisdiction
	1	46	FRASER	BELCONNEN	Australian Capital Territory

Plans

B20225225/A

Building Works

Class of Occupancy	Nature of Work	Project Item Description	Other Description	Type Of Const.	Unit	BCN ID	Builder
10b	New	DA EXEMPT-SWIMMING POOL	Proposed Swimming Pool & Fence	NA		B20225225N1	JOHN ROBERT MCLEAN

Comments

Important Note:

The issue, under this Part, of a certificate in respect of a building or portion of a building does not affect the liability of a person to comply with the provisions of a law of the territory (including this Act) relating to the building or portion of the building.

Issued by: Ashleigh Morris

Issued on: 20/05/2024

Delegate of the ACT Construction
Occupations Registrar.

GENERAL NOTES:
 ALL WORK MUST COMPLY WITH THE BCA & ALL RELEVANT CURRENT AUSTRALIAN STANDARDS ALL DIMENSIONS ARE IN MILLIMETERS. DIMENSIONS TAKE PREFERENCE OVER SCALE & ARE TO STRUCTURE NOT FINISH. ALL DIMENSIONS MUST BE VERIFIED ON SITE BEFORE COMMENCING ANY WORK BLOCK DIMENSIONS AND LEVELS HAVE BEEN TAKEN FROM INFORMATION PROVIDED AND NO RESPONSIBILITY IS TAKEN FOR THE ACCURACY OF THIS INFORMATION. ANY DISCREPANCIES TO BE DIRECTED TO BUILDER &/OR DESIGNER IMMEDIATELY. INCLUSIONS LIST TO TAKE PRECEDENCE OVER DRAWINGS. CARRY OUT ALL WORK IN COMPLIANCE WITH THE RELEVANT SAA & NCC CODES OF PRACTICE IN THE BEST TRADESMAN-LIKE MANNER TO THE APPROVAL OF THE BUILDING CERTIFIER & AUTHORITIES HAVING JURISDICTION OVER THE WORKS INCLUDING BUT NOT RESTRICTED TO: ACT GOVERNMENT. BUILDING CODE OF AUSTRALIA & THE ACT APPENDIX. ACT ELECTRICITY & WATER. AS1684 TIMBER FRAMING CODE & AS FURTHER SPECIFIED. MATERIALS & WORKMANSHIP TO BE IN ACCORDANCE WITH THE BCA, ALL OTHER RELEVANT CODES & AUSTRALIAN STANDARDS. PROVIDE SMOKE ALARMS IN ACCORDANCE WITH PART 3.7.2 OF THE BCA, ELECTRICIAN TO CONFIRM. RELEVANT CODES AS 1926.1 - AS 1926.2 2012 - SWIMMING POOL SAFETY AS 1988 - 1994 - GLASS IN BUILDINGS SELECTIONS & INSTALLATION. AS 1562 - 1992 - DESIGN & INSTALLATION OF SHEET ROOF & WALL CLADDING. AS 1694 - 1999 - NATIONAL TIMBER FRAMING CODE. AS 2049 - 1992 - ROOF TILES. AS 2050 - 1995 - INSTALLATION OF ROOF TILES. AS 2870 - 1996 - RESIDENTIAL SLAB & FOOTINGS - CONSTRUCTION. AS/NZS 2904 - 1995 - DAMP-PROOF COURSE & FLASHINGS. AS 3600 - 1994 - CONCRETE STRUCTURES. AS 3660 - 2004 - BARRIERS FOR SUBTERRANEAN TERMITES. AS 3700 - 1998 - MASONRY IN BUILDINGS. AS 3786 - 1993 - WATERPROOFING OF WET AREAS IN RESIDENTIAL BUILDING. AS 4055 - 1992 - WIND LOADING FOR HOUSES, 13. AS 4100 - 1996 - STEEL STRUCTURES. WASTE MANAGEMENT: THIS DEVELOPMENT WILL COMPLY WITH TERRITORY AND MUNICIPAL SERVICE IN ACCORDANCE WITH THE DEVELOPMENT CODE FOR WASTE MANAGEMENT IN THE A.C.T. 1999. CONTOURS TAKEN FROM EXISTING INFORMATION AVAILABLE NOT FOR CONSTRUCTION 0.250 CONTOURS SHOWN HALFTONE

A licenced Plumber to submit works Executed plan to plumbing section of Access Canberra
 A licenced Electrician to submit C.E.S form to Electrical section of Access Canberra.
 Erosion & sediment Control
 - Development to comply with ACT environment protection authority, environment protection guidelines for construction & land Development in the ACT August 2007

THIS PLAN AND APPROVAL ONLY RELATES TO THE PROPOSED SWIMMING POOL/SPA / WATER FEATURE, ASSOCIATED POOL FENCING AND MODIFICATION TO WINDOWS WITHIN THE POOL ZONE AS SPECIFIED.

ITEMS FOR APPROVAL:
 1. PROPOSED FIBERGLASS POOL & ASSOCIATED POOL BARRIER

Type (Line Colour Refers to Fence type)	Material	Mandatory Height (mm)	Max Gap between Railing/Panel/ Ground/Opening s (mm)	Latch Height	Max Gap between bottom of fence to ground	Internal (Pool Area) Non-Climbable Zone	External (Non-Pool area) Non-Climbable Zone
A	Glass Panels	1200	10	1200	100	300	900
B	Metal Tubular	1200	100	1200	100	300	900
C	Timber Boundary	1800	N/A	1200	N/A	900	N/A
D	Metal Boundary	1800	N/A	1200	N/A	900	N/A
E	Courtyard Wall	1800	10	1200	100	900	N/A
F	Existing Structure Garage/House	N/A	100mm Opening in all windows into pool area	N/A	N/A	N/A	N/A

Please refer to Swimming Pool Barrier details provided as part of the approved plan package for construction details.
 Gates shall be hung so they only swing outwards, i.e. away from the pool area.
 Gates shall be fitted with a self-closing device that will close the gate from any position with a stationary start, without the application of a manual force and operate the latch. (Refer to AS 1926.1 & 1926.2 for further Details).

Draft Up
 BUILDING DESIGN
 www.draftupbuildingdesign.com.au Ph: 0403 714 311

Client: Johns Designer pools
 Project: Swimming Pool Approval

Block: 1 Section: 46
 Suburb: Fraser
 Address: 34 CARRODUS STREET

Rev	Issued	Description

Site Plan		Status	For Approval	
				A01
Drawn by	J.M			
Sheet size	A3	Scale	1 : 200	

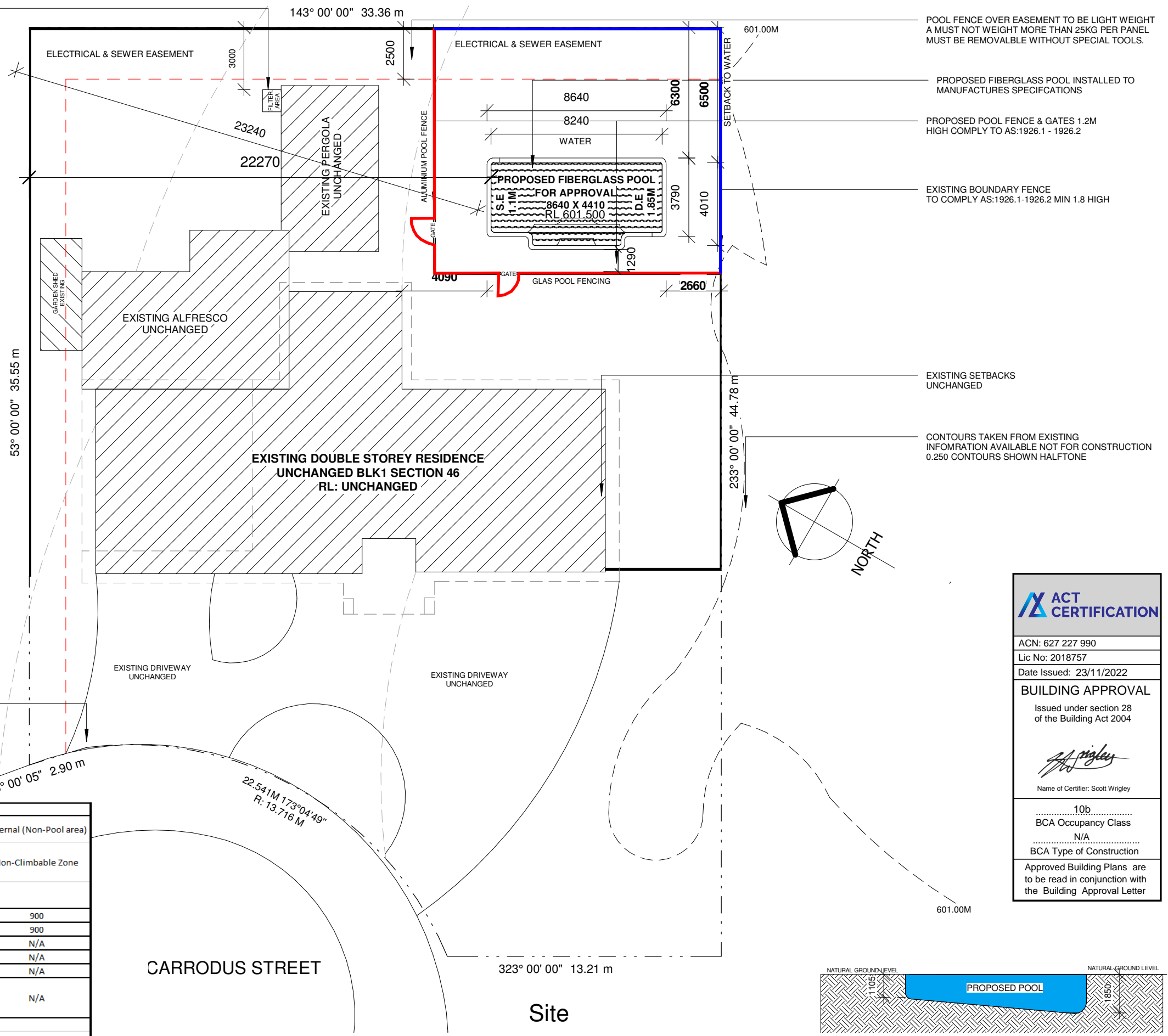

ACT CERTIFICATION
 ACN: 627 227 990
 Lic No: 2018757
 Date Issued: 23/11/2022

BUILDING APPROVAL
 Issued under section 28 of the Building Act 2004

Scott Wrigley
 Name of Certifier: Scott Wrigley

10b
 BCA Occupancy Class: N/A
 BCA Type of Construction: Approved Building Plans are to be read in conjunction with the Building Approval Letter

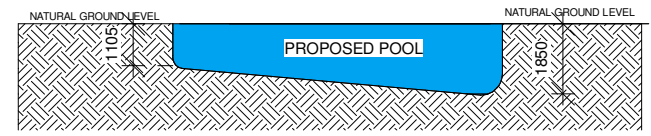

Site
 1 : 200

**POOL BARRIER NOTES:
ALL BARRIERS TO COMPLY TO AS 1926.1 - AS 1926.2 2012**

GENERAL:

A BARRIER SHALL BE DESIGNED AND CONSTRUCTED SO THAT IT WILL RESTRICT ACCESS BY YOUNG CHILDREN. THE BARRIER SHALL BE A PERMANENT STRUCTURE. THE HEIGHT OF THE BARRIER WITHIN THE PROPERTY SHALL NOT BE LESS THAN 1200MM HIGH ON THE OUTSIDE OF THE BARRIER. BARRIERS MAY BE CONSTRUCTED FROM ANY DURABLE MATERIAL, PROVIDED THE BARRIER COMPLIES WITH THE REQUIREMENTS OF AUSTRALIAN STANDARDS 1926.1. A BARRIER OTHER THAN A RETAINING WALL SHALL BE VERTICAL OR LEAN AWAY FROM THE POOL BY NOT MORE THAN 15 DEG.

NON CLIMABLE ZONE (NCZ):

NCZ 1: IS A 900MM VERTICAL PLANE ON THE OUTSIDE FACE OF A BARRIER. THIS NCZ MAY BE LOCATED ANYWHERE WITHIN THE PERPENDICULAR HEIGHT OF A BARRIER.
 NCZ 2: IS A QUADRANT ON THE OUTSIDE OF A BARRIER. CREATED BY A 900MM RADIUS DOWN FROM THE TOP OF NCZ1.
 NCZ 3: IS A QUADRANT ON THE OUTSIDE OF A BARRIER CREATED BY A 900MM RADIUS UP FROM THE TOP OF THE BARRIER.
 NCZ 4: IS REQUIRED ON ALL BARRIER WITH VERTICAL OPENNING 10-100MM IN WIDTH AND IS A 900MM HIGH BY 300MM WIDE DEEP RECTANGULAR SPACE ON THE INSIDE OF THE BARRIER AND SHALL ALIGN WITH NCZ1.

GATE UNITS & LATCH FITTINGS:

GATES SHALL BE HUNG SO THAT THEY ONLY SWING OUTWARDS IE AWAY FROM THE POOL AREA. GATES SHALL BE LOCATED SO THAT THE ARC OF PERATION IS CLEAR OF ANY BUILDING OR DOOR WAY. GATES SHALL HAVE SUFFICIENT CLEARANCE TO SWING FREELY THROUGH THE ARC OF OPERATION. THE OPENING UNDER A CLOSED GATE SHALL NOT EXCEED 100MM AT ANY POINT.

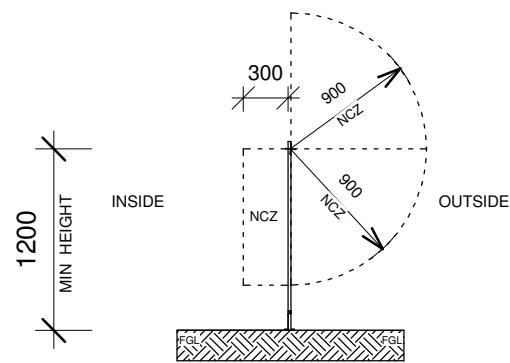

SIDE ELEVATION TYPICAL METAL POOL BARRIER

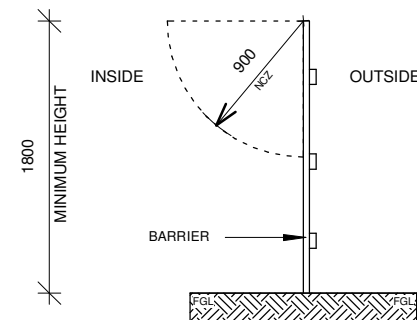

SIDE ELEVATION TYPICAL BOUNDARY BARRIER

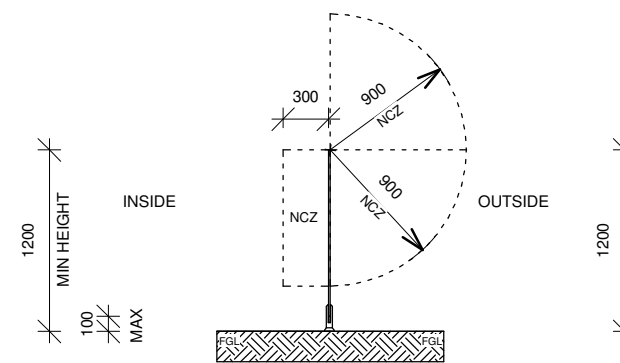

SIDE ELEVATION TYPICAL GLASS POOL BARRIER

GATE HINGES SHALL BE SELF CLOSING.

GATE HINGES THAT PROTRUDE OUT FROM THE BARRIER WITH A HORIZONTAL TOP SURFACE DEPTH GRATER THAN 10MM AND THOSE WHICH CREATE AN OPENING BETWEEN THE GATE POST OF MORE THAN 10MM SHALL NOT BE PERMITTED IN NON CLIMABLE ZONE 1 & 2

GATES SHALL BE FITTED WITH A LATCH THAT WILL AUTOMATICALLY OPERATE ON CLOSING OF THE GATE AND WILL PREVENT THEGATE FROM BEING RE-OPENED WITHOUT BEING MANUALLY RELEASED.

GATE HINGES SHALL BE SELF CLOSING.

GATE HINGES THAT PROTRUDE OUT FROM THE BARRIER WITH A HORIZONTAL TOP SURFACE DEPTH GRATER THAN 10MM AND THOSE WHICH CREATE AN OPENING BETWEEN THE GATE POST OF MORE THAN 10MM SHALL NOT BE PERMITTED IN NON CLIMABLE ZONE 1 & 2

GATES SHALL BE FITTED WITH A LATCH THAT WILL AUTOMATICALLY OPERATE ON CLOSING OF THE GATE AND WILL PREVENT THE GATE FROM BEING RE-OPENED WITHOUT BEING MANUALLY RELEASED.

IF LATCH IS LOCATED LESS THAN 1500MM ABOVE FINISH GROUND LEVEL THE LOCATION OF THE LATCH SHALL
 1. NOT BE ON THE OUTSIDE OF THE BARRIER
 2. BE IN SUCH A POSTION THAT TO RELEASE THE LATCH FROM THE OUTSIDE IT WILL BE NECESSARY TO REACH OVER THE BARRIER AT A HEIGHT OF NOT LESS THAN 1200MM
 3. BE ATLEAST 150MM BELOW THE TOP OF THE BARRIER.

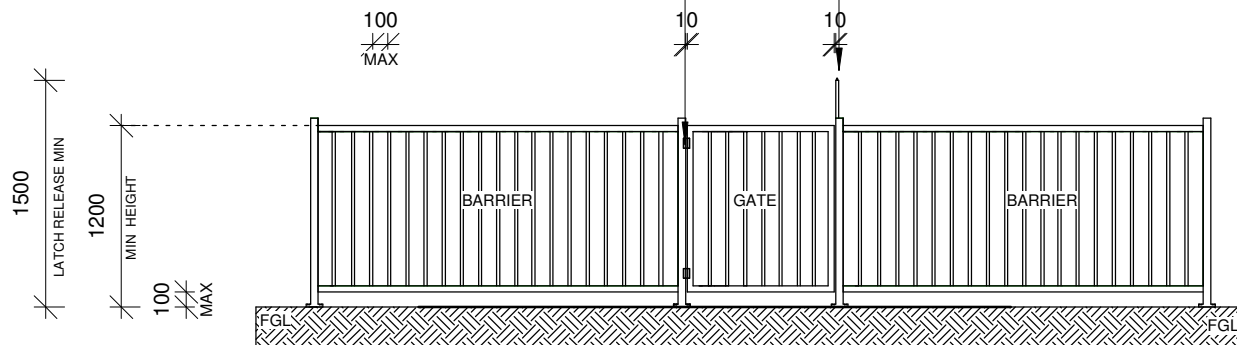

FRONT ELEVATION TYPICAL ALUMINIUM POOL BARRIER

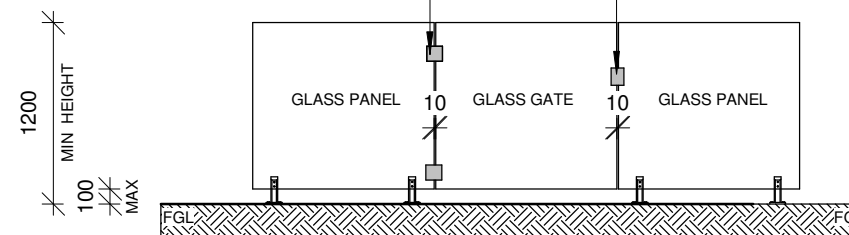

FRONT ELEVATION TYPICAL GLASS POOL BARRIER

ACT CERTIFICATION
 ACN: 627 227 990
 Lic No: 2018757
 Date Issued: 23/11/2022
BUILDING APPROVAL
 Issued under section 28 of the Building Act 2004

 Name of Certifier: Scott Wrigley
 10b
 BCA Occupancy Class
 N/A
 BCA Type of Construction
 Approved Building Plans are to be read in conjunction with the Building Approval Letter

Draft Up
 BUILDING DESIGN
 www.draftupbuildingdesign.com.au Ph: 0403 714 311

Client: Johns Designer pools
 Project: Swimming Pool Approval

Block: 1 Section: 46
 Suburb: Fraser
 Address: 34 CARRODUS STREET

Rev	Issued	Description

Structural Details & Elevations		
Status	For Approval	A03
Drawn by	J.M	
Sheet size	A3	Scale 1 : 50



ACN: 627 227 990
 Lic No: 2018757
 Date Issued: 23/11/2022

BUILDING APPROVAL

Issued under section 28 of the Building Act 2004

Scott Wrigley
 Name of Certifier: Scott Wrigley

10b
 BCA Occupancy Class
 N/A
 BCA Type of Construction

Approved Building Plans are to be read in conjunction with the Building Approval Letter

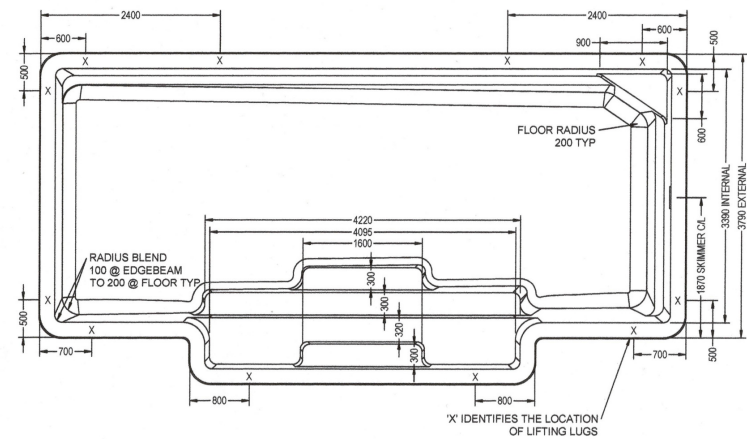

PLAN

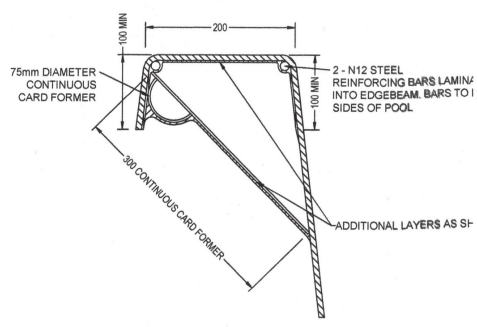

EDGE BEAM DETAIL
 SCALE 1:5

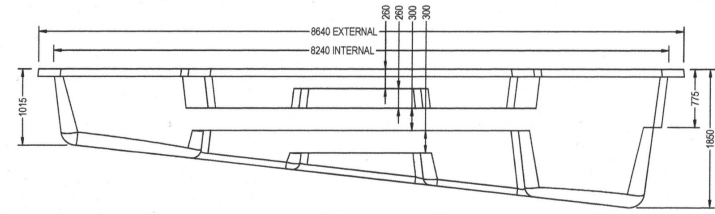

SIDE ELEVATION

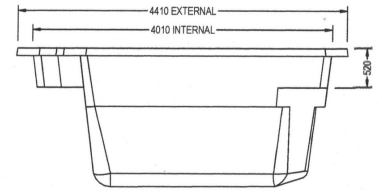

DEEP END ELEVATION

REFER TO DRALT-003 FOR /
 STRUCTURAL SPECIFIC.

COPY OF ORIGINAL FOR REFERENCE ONLY

AQUATIC LEISURE TECHNOLOGIES PTY LTD
 28 Orion Road, Jandakot WA 6164
 t: +61 8 9258 5000 f: +61 8 9258 5500 e: info@aquaticleisure.com.au
 ACN 008 905 888 ABN 23 008 905 888 www.aquaticleisure.com.au
 COPYRIGHT RESERVED - This drawing and all information thereon remains the property of Aquatic Leisure Technologies Pty Ltd and must not be reproduced, copied or communicated to any other party without our permission.

REVISION SUMMARY				GENERAL DETAILS			ALT DRAWING DET	
Rev:	Date:	Description:	Drawn By:	UNSPECIFIED RADII	INTERNAL - CONCAVE EXTERNAL - CONVEX	30	Brand:	SAPPHIRE
2	17-03-2017	DOCUMENT CONTROL UPDATE	MCA	RELEASE ANGLE	TYPICAL	6.843°	Title:	GRANDEUR - DETAILS
Previous revisions are available in superseded drawings.				NON-SKID TO ALL FLAT TRAFFICABLE AREAS			No:	DRSP-023-ED
				ALL DIMENSIONS IN MM UNLESS OTHERWISE STATED			Rev:	2
							Scale:	1:50 U.N.O.

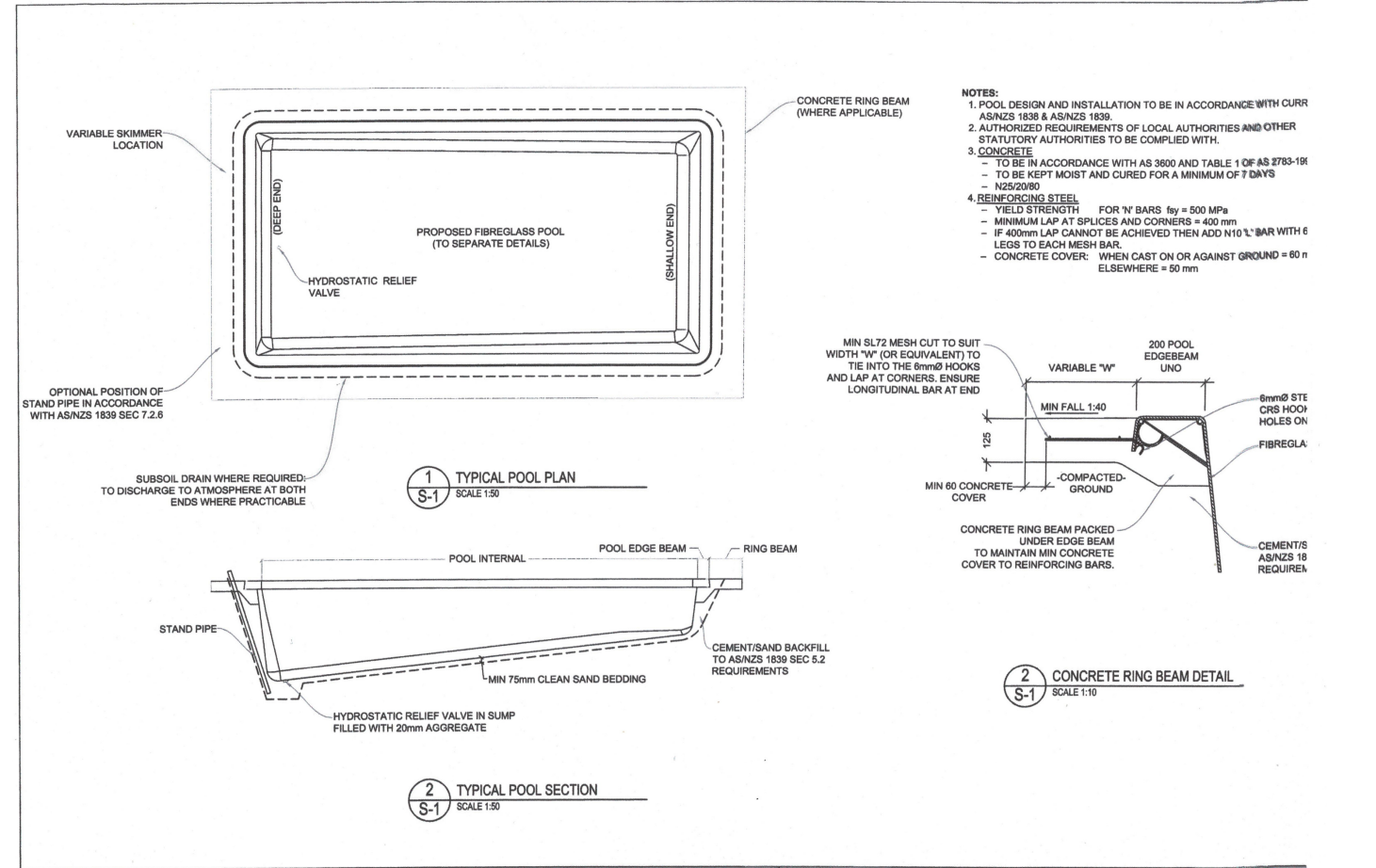

- NOTES:**
- POOL DESIGN AND INSTALLATION TO BE IN ACCORDANCE WITH CURR AS/NZS 1838 & AS/NZS 1839.
 - AUTHORIZED REQUIREMENTS OF LOCAL AUTHORITIES AND OTHER STATUTORY AUTHORITIES TO BE COMPLIED WITH.
 - CONCRETE
 - TO BE IN ACCORDANCE WITH AS 3600 AND TABLE 1 OF AS 2783-19
 - TO BE KEPT MOIST AND CURED FOR A MINIMUM OF 7 DAYS
 - N25/20/80
 - REINFORCING STEEL
 - YIELD STRENGTH FOR N BARS fy = 500 MPa
 - MINIMUM LAP AT SPLICES AND CORNERS = 400 mm
 - IF 400mm LAP CANNOT BE ACHIEVED THEN ADD N10 L BAR WITH 6 LEGS TO EACH MESH BAR.
 - CONCRETE COVER: WHEN CAST ON OR AGAINST GROUND = 80 mm ELSEWHERE = 50 mm

1 TYPICAL POOL PLAN
 S-1 SCALE 1:50

2 TYPICAL POOL SECTION
 S-1 SCALE 1:50

2 CONCRETE RING BEAM DETAIL
 S-1 SCALE 1:10

AQUATIC LEISURE TECHNOLOGIES PTY LTD
 9 Stott Road, Welshpool WA 6106
 t: +61 8 9258 5000 f: +61 8 9258 5500 e: info@aquaticleisure.com.au
 ACN 008 905 888 ABN 23 008 905 888 www.aquaticleisure.com.au
 COPYRIGHT RESERVED - This drawing and all the information thereon remains the property of Aquatic Leisure Technologies Pty Ltd and must not be reproduced, copied or communicated to any other party without our permission.

Rev:	Date:	Description:	Drawn By:
2	06-08-2014	NOTE ADDED	MBA
1	03-07-2014	REVISED DETAIL	MBA
0	08-04-2014	ORIGINAL	MBA

GENERAL NOTES:
 THIS DRAWING IS TO BE READ IN CONJUNCTION WITH AQUATIC LEISURE TECHNOLOGIES POOL DETAILS AND OTHER RELEVANT DOCUMENTS

ALT DRAWING DETAIL	
Brand:	AQUATIC LEISURE TECHNOLOGIES
Title:	DRAINAGE AND RING BEAM DETAIL
No:	FIBREGLASS INSTALLATIONS IN NON-FREE-DRAINING SITES
No:	DRALT-017 - ED
Rev:	2
Scale:	AS STATED

www.draftupbuildingdesign.com.au Ph: 0403 714 311

Client: Johns Designer pools
 Project: Swimming Pool Approval

Block: 1 Section: 46
 Suburb: Fraser
 Address: 34 CARRODUS STREET

Rev	Issued	Description

Structural Details & Elevations	
Status	For Approval
Drawn by	J.M
Sheet size	A3
Scale	1 : 100

PLAN OF SANITARY DRAINAGE

FOR

OWNER: MR & MRS A. BALAZS

BLOCK: 1 SECTION: 46 FRASER

REFERENCE

G.T. GULLY TRAP
D.T. DISCONNECTOR TRAP
C.I.P. CAST IRON PIPE

S.P.D. STONEWARE PIPE DRAIN
S.V.P. SOIL VENT PIPE
V.P. VENTILATING PIPE

E.V. EDUCT VENT
I.O. INSPECTION OPENING

NOTE: All work to be executed in accordance with the Canberra Sewerage and Water Supply Regulations.

SCALE: 1 : 500

FIXTURES: 1. W. CLOSET
4. SHOWER

2. BASIN
5. TROUGH

3. BATH
6. SINK

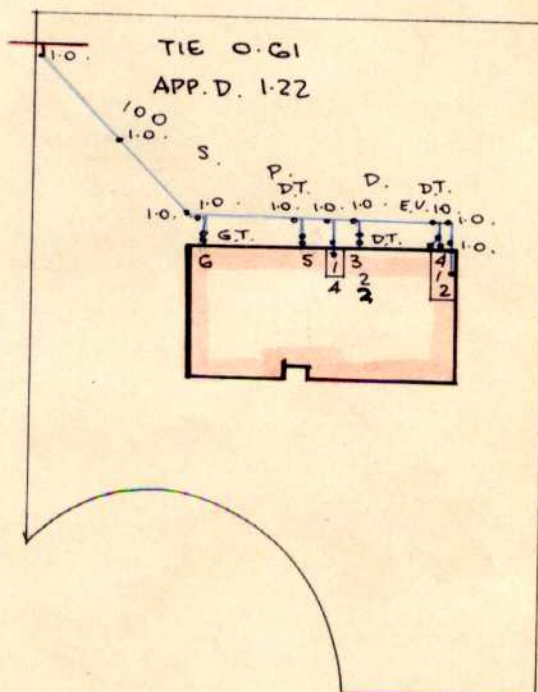

NOTE:

1. DRAINS TO BE LAID SHOWN IN BLUE LINES.
2. THIS PLAN TO BE READ IN CONJUNCTION WITH APPROVED ARCHITECTURAL PLANS AND SPECIFICATIONS.
3. DRAINS TO BE SUPPORTED ON OR FROM SOLID GROUND.
4. SEWER BRANCH TO BE LOCATED ON SITE BEFORE ANY WORK IS COMMENCED.
5. EXISTING DRAINS SHOWN IN GREEN LINES.
6. EXISTING DRAINS X'ed IN RED TO BE ABOLISHED TO APPROVAL.

W. Gillabea
Sewerage Engineer
21. 5. 1975

PAYMENT PENDING

As per terms and conditions in the Residential Reports Client Guarantee



Tax Invoice

Inspection Number 46231

Please ensure this number is used when making payment

10 March 2026

John Dessent & Allison Johnston

For the Property at: 34 Carrodus Street Fraser ACT 2615

NO PAY UPFRONT RAPID INSPECTIONS PACKAGE	
Access Canberra conveyancing fees (no GST)	181.00
Property Inspection and Report (package price)	520.00
Timber Pest Inspection and Report (package price)	490.00
Building Compliance Inspection and Report (package price)	475.45
First Rate Energy Efficiency Inspection & Report (complimentary)	0.00
Subtotal	1,666.45
Total GST	148.55
TOTAL INC GST	\$1,815.00

Thank you for your business

We offer comprehensive Pest Management Solutions!
Call now to book your regular Pest Control Service

No Pay Package Conditions: This invoice must be paid on settlement or within 180 days of the date of inspection, whichever comes first. We must be notified immediately if the property is not marketed within 3 months or is withdrawn from the market and the invoice must be settled within 14 days. Failure to adhere to these terms will result in associated legal and collection fees being applied to amount due.

PAYMENT OPTIONS	
	To avoid unallocated payments please use reference number: 46231
Credit Card	Please call 6288 0402 to provide card details. Your account is not debited until the day reports are released. Providing these details as soon as possible will ensure there is no delay when reports are ready.
Direct Deposit	Account Name: Residential Reports BSB: 012-997 Account Number: 2269 05945 Reference: 46231 IMPORTANT: PLEASE ensure this unique ID is used



A PERCENTAGE OF EVERY JOB IS DONATED TO OUR WITHOUT A ROOF PROGRAM

Every year we step into hundreds of homes, yet in our region there are still so many people living without acceptable, permanent or safe shelter. A percentage from each inspection we conduct is contributed to our in-house program 'Without a Roof' and periodically donated to make small changes to this big issue. To find out more visit residentialreports.com.au

Residential Reports Pty Limited **ABN 38 609 880 122**

35 Poynton Street Hughes ACT 2605 **p 6288 0402** info@residentialreports.com.au

Member- Master Builders Association & The Australian Environmental Pest Managers Association

If a home was built before 1990 it may contain dangerous asbestos material

Identify where asbestos materials might be. Five common places are:



1. Exterior
roof sheeting, gutters, downpipes,
ridge capping, eaves, cladding,
electrical switchboards

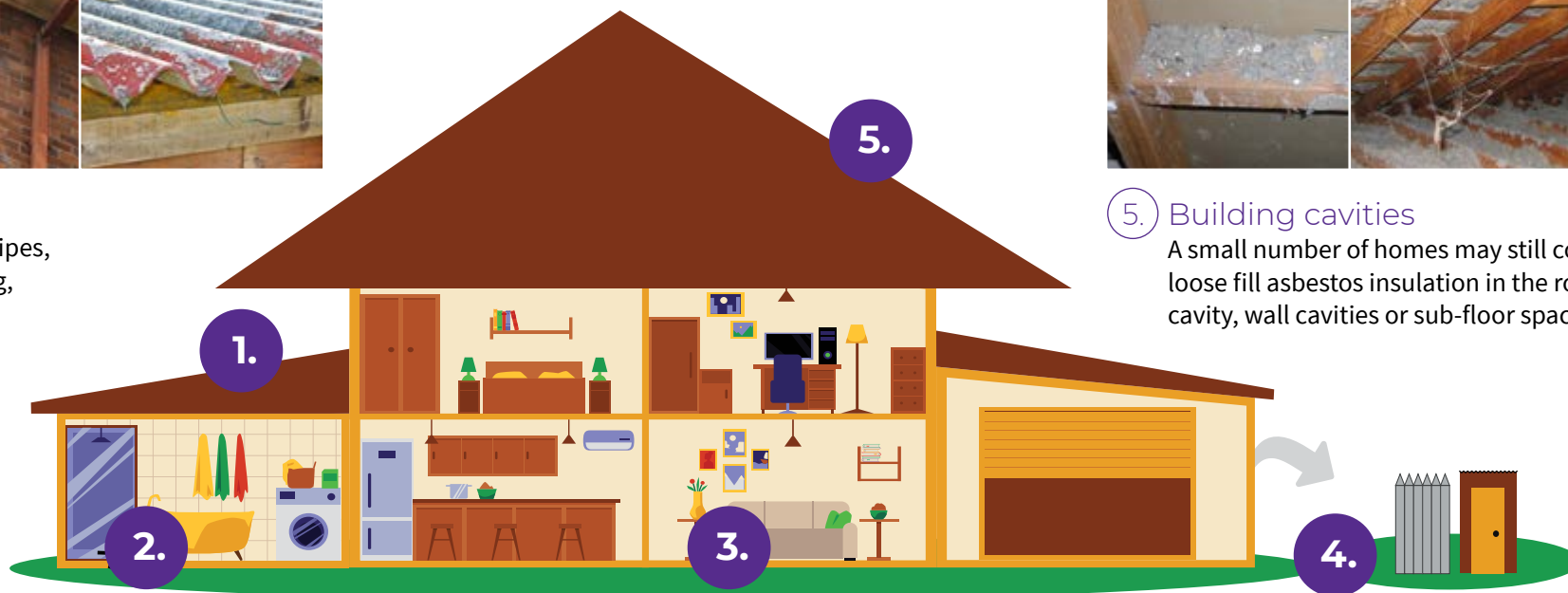

5. Building cavities
A small number of homes may still contain
loose fill asbestos insulation in the roof
cavity, wall cavities or sub-floor space



2. Wet areas - bathroom, laundry and kitchen
wall and ceiling panels, vinyl floor tiles, backing for wall tiles
and splashbacks, hot water pipe insulation



3. Internal areas
wall and ceiling panels, carpet underlay,
textured paints, insulation in domestic
heaters



4. Backyard
fences, sheds, garages, carports, dog kennels, buried or
dumped waste, letterboxes, swimming pools

If a home was built before 1990 it may contain dangerous asbestos material

Assess the risk

A licensed asbestos assessor can help identify asbestos in your home and its condition.

Asbestos materials become dangerous when:



Broken or in poor condition



Damaged accidentally



Disturbed during renovation or repairs



Loose fill asbestos insulation



Manage asbestos safely

- Monitor the condition of asbestos in your home
- Inform tradespeople of locations of asbestos in your home
- Avoid disturbing or damaging asbestos if working on your home
- Engage a licensed asbestos removalist to remove asbestos

If you suspect your home contains loose fill asbestos insulation, contact Access Canberra.

RW Amount

(residential withholding payment) — further details

The supplier will frequently be the Seller. However, sometimes further information will be required as to which entity is liable for GST (eg if the Seller is part of a GST group, where the GST representative has the GST liability). If more than one supplier, provide details for each supplier.

Supplier	Name			
	ABN		Phone	
	Business address			
	Email			
Residential Withholding Tax	Supplier's portion of the RW Amount:		\$	
	RW Percentage:			%
	RW Amount (ie the amount that the Buyer is required to pay to the ATO):		\$	
	Is any of the consideration not expressed as an amount in money?	<input type="checkbox"/> No	<input type="checkbox"/> Yes	
	If 'Yes', the GST inclusive market value of the non-monetary consideration:		\$	
	Other details (including those required by regulation or the ATO forms):			

Cooling Off Period

(for residential property only)

- 1 The Buyer may rescind this Contract at any time before 5pm on the 5th Business Day after the day this Contract is made except if any circumstance in paragraph 2 applies.
- 2 There is no cooling off period if:
 - the Buyer is a corporation; or
 - the Property is sold by tender; or
 - the Property is sold by auction; or
 - before signing this Contract, the Buyer gives the Seller a certificate in the form required by the Sale of Residential Property Act signed by the Buyer Solicitor; or
 - this Contract is made on the same day the Property was offered for sale by auction but passed in and the Buyer was recorded in the bidders record as a bidder or a person for whom a bidder was bidding.
- 3 A Buyer exercising the cooling off right by rescinding this Contract forfeits 0.25% of the Price. The Seller is entitled to recover the amount forfeited from the Deposit and the Buyer is entitled to a refund of any balance.

Warnings

- 1 The Lease may be affected by the *Residential Tenancies Act 1997 (ACT)* or the *Leases (Commercial & Retail) Act 2001 (ACT)*.
- 2 If a consent to transfer is required by law, see clause 4 as to the obligations of the parties.
- 3 As some risks associated with the Property pass from the Seller to Buyer on the Date of this Contract, (except if the Property is a Unit) the Buyer should take out insurance on the Property on the Date of this Contract.
- 4 The Buyer will usually have to pay stamp duty on the purchase of the Land. The Buyer may incur penalties if the Buyer does not pay the stamp duty within the required time.
- 5 There are serious risks to a Buyer releasing the Deposit before Completion. The Buyer should take legal advice before agreeing to release the Deposit.
- 6 The Buyer should consider the application of the Territory Plan and other planning and heritage issues before signing this Contract.
- 7 If the Lease is a concessional lease then restrictions on transfer and other dealings may apply.

Disputes

If there is a dispute, the Law Society encourages the use of informal procedures such as negotiation, independent expert appraisal or mediation to resolve the dispute.

Exchange of Contract

1 An Agent, authorised by the Seller, may:

- insert:
 - the name and address of, and contact details for, the Buyer;
 - the name and address of, and contact details for, the Buyer Solicitor;
 - the Price;
 - the Date of this Contract,
- insert in, or delete from, the Goods; and
- exchange this Contract.

2 An Agent must not otherwise insert, delete or amend this Contract.

3 **The Agent must not exchange this Contract unless expressly authorised by the Seller or (if a solicitor is acting for the Seller) by the Seller or the Seller Solicitor.**

The Seller agrees to sell and the Buyer agrees to buy the Property for the Price on these terms:

1. Definitions and interpretation

1.1 Definitions appear in the Schedule and as follows:

Affecting Interests means any mortgage, encumbrance, lease, lien, charge, notice, order, caveat, writ, or other interest;

Adaptable Housing Dwelling has the meaning in the Sale of Residential Property Act;

Agent has the meaning in the Sale of Residential Property Act;

ATO means the Australian Taxation Office, and includes the Commissioner for Taxation;

Balance of the Price means the Price less the Deposit;

Breach of Covenant means:

- a Development not approved under the Planning Act including a development for which design and siting approval has not been obtained;
- a breach of the Building and Development Provision;

- a breach of any obligation of the Seller in a registered restrictive covenant affecting the Lease;
- a breach of any other term of the Lease;
- a breach of the articles of the Owners Corporation (if the Property is a Unit); or
- an Unapproved Structure;

Building Act means the *Building Act 2004* (ACT);

Building and Development Provision has the meaning in the Planning Act;

Building Conveyancing Inquiry Document has the meaning in the Sale of Residential Property Act;

Building and Compliance Inspection Report has the meaning in the Sale of Residential Property Act;

Building Management Statement has the meaning in the Land Titles Act;

Business Day means any day other than a Saturday, Sunday, public holiday or bank holiday in the Australian Capital Territory;

Class A Unit has the meaning in the Sale of Residential Property Act;

Common Property for a Unit has the meaning in the Unit Titles Act;

Common Property for a Lot that forms part of a Community Title Scheme has the meaning in the Community Title Act;

Community Title Act means the *Community Title Act 2001* (ACT);

Community Title Body Corporate means the entity referred to as such in the Community Title Act;

Community Title Management Statement has the meaning in the Community Title Act;

Community Title Master Plan has the meaning in the Community Title Act;

Community Title Scheme has the meaning in the Community Title Act;

Completion means the time at which this Contract is completed and **Completed** has a corresponding meaning;

Compliance Certificate means a certificate issued for the Lease under section 296 of the *Planning and Development Act 2007*, Division 10.12.2 of the Planning Act or under section 28 of the *City Area Leases Act 1936* or under section 180 of the Land Act;

Covenant includes a restrictive covenant;

Default Notice means a notice in accordance with clause 18.5 and clause 18.6

Default Rules has the meaning in the Unit Titles Management Act;

Deposit means the deposit forming part of the Price;

Developer in respect of a Lot has the meaning in the Community Title Act;

Developer Control Period has the meaning in the Unit Titles Management Act;

Development has the meaning in the Planning Act;

Development Statement has the meaning in the Unit Titles Act;

Disclosure Statement has the meaning in the Property Act;

Disclosure Update Notice has the meaning in section 260(2) of the Property Act;

Encumbrance has the meaning in the Sale of Residential Property Act but excludes a mortgage;

Energy Efficiency Rating Statement has the meaning in the Sale of Residential Property Act;

Excluded Change has the meaning in section 259A(4) of the Property Act;

General Fund Contribution has the meaning in section 78(1) of the Unit Titles Management Act;

GST has the meaning in the *A New Tax System (Goods and Services Tax) Act 1999* (Cth);

GST Rate means the prevailing rate of GST specified as a percentage;

Improvements means the buildings, structures and fixtures erected on and forming part of the Land;

Income includes the rents and profits derived from the Property;

Land Act means the *Land (Planning & Environment) Act 1991* (ACT);

Land Charges means rates, land rent, land tax and other taxes and outgoings of a periodic nature in respect of the Property;

Land Rent Act means the *Land Rent Act 2008* (ACT);

Land Rent Lease means a Lease that is subject to the Land Rent Act;

Land Titles Act means the *Land Titles Act 1925* (ACT);

Lease means the lease of the Land having the meaning in the Planning Act;

Lease Conveyancing Inquiry Document has the meaning in the Sale of Residential Property Act;

Legislation Act means the *Legislation Act 2001*;

Liability of the Owners Corporation means any actual or contingent liability of the Owners Corporation attributable to the Unit on a Unit Entitlement basis (other than normal operating expenses) or expenditure to be made by the Owners Corporation to fulfil its obligations under the Unit Titles Management Act;

Lot has the meaning in the Community Title Act;

Non-Land Rent Lease means a Lease that is not subject to the Land Rent Act;

Notice to Complete means a notice in accordance with clause 18.1 and clause 18.2 requiring a party to complete;

Owners Corporation means the Owners Corporation for the Unit constituted or to be constituted under the Unit Titles Management Act following registration of the Units Plan;

Pest Inspection Report has the meaning in the Sale of Residential Property Act;

Pest Treatment Certificate has the meaning in the Sale of Residential Property Act;

Planning Act means the *Planning Act 2023* (ACT);

Planning and Land Authority has the meaning in the Legislation Act;

Prescribed Building has the meaning in the Building Act;

Prescribed Terms has the meaning in the Residential Tenancies Act;

Property means the unexpired term of the Lease, the Improvements and the Goods, or (if the Land is a Unit) the unexpired term of the Unit Lease, the Improvements and the Goods;

Property Act means the *Civil Law (Property) Act 2006* (ACT);

Required Documents has the meaning in the Sale of Residential Property Act and includes a Unit Title Certificate but excludes a copy of this Contract;

Rescission Notice has the meaning in the Sale of Residential Property Act;

Residential Tenancies Act means the *Residential Tenancies Act 1997* (ACT);

Sale of Residential Property Act means the *Civil Law (Sale of Residential Property) Act 2003* (ACT);

Section 56 Certificate means a certificate for a Lot issued under section 56 of the Community Title Act;

Section 67 Statement means a statement for a Lot complying with section 67(2)-(4) of the Community Title Act;

Service includes air, communication, drainage, electricity, garbage, gas, oil, radio, sewerage, telephone, television, or water service;

Staged Development has the meaning given by section 17(4) of the Unit Titles Act;

Tenancy Agreement includes a lease for any term and whether for residential purposes or otherwise;

Unapproved Structure has the meaning in the Sale of Residential Property Act;

Unit means the Unit referred to in the Schedule and which has the meaning in the Unit Titles Act;

Unit Entitlement for the Unit has the meaning in the Unit Titles Act;

Unit Title is the Lease together with the rights of the registered lessee of the Unit;

Unit Title Certificate means a certificate for the Unit issued under section 119 of the Unit Titles Management Act;

Unit Titles Act means the *Unit Titles Act 2001* (ACT);

Unit Titles Management Act means the *Unit Titles (Management) Act 2011* (ACT);

Units Plan means all the documents relating to the subdivision of the Land registered as the Units Plan for the Unit under the *Land Titles (Unit Titles) Act 1970*; and

Withholding Law means Subdivision 14 of Schedule 1 of the *Taxation Administration Act 1953* (Cth) and associated provisions.

1.2 In this Contract:

- a reference to the Seller or to the Buyer includes the executors, administrators and permitted assigns of any of them, if an individual, and the successors or permitted assigns of any of them, if a corporation;
- the singular includes the plural, and the plural includes the singular;
- a reference to a person includes a body corporate;
- a term not otherwise defined has the meaning in the Legislation Act; and
- a reference to an Act includes a reference to any subordinate legislation made under it or any Act which replaces it.

1.3 Headings are inserted for convenience only and are not part of this Contract.

1.4 If the time for something to be done or to happen is not a Business Day, the time is extended to the next Business Day, except in the case of clause 2.1.

1.5 A reference to “this Contract” extends to the Schedule, any annexure, additional clauses and attachments forming part of this Contract.

1.6 If there is more than one buyer or more than one seller the obligations which they undertake bind them jointly and individually.

1.7 Where the Buyer consists of more than one person, as between themselves, they agree to buy the Property in the specified manner of Co-ownership or if one alternative is not marked, as joint tenants.

1.8 Without limiting clause 13, the parties agree that for the purposes of the *Electronic Transactions Act 2001* (ACT) and the *Electronic Transactions Act 1999* (Cth), this Contract may be signed and/or exchanged electronically.

2. Terms of payment

2.1 The Buyer must pay the Deposit on the Date of this Contract, to the Stakeholder or, if no Stakeholder is named, then to the Seller.

2.2 The Deposit becomes the Seller’s property on Completion.

2.3 The Deposit may be paid by cheque or in cash (up to \$3,000.00) but if it is not paid on time or, if it is paid by cheque which is not honoured on first presentation, the Buyer is in default.

2.4 If the Buyer is in default under clause 2.3, then immediately and without the notice otherwise necessary under clause 18, clause 19 applies.

2.5 On Completion the Buyer must give the Seller an authority directing the Stakeholder to account to the Seller for the Deposit.

2.6 On Completion the Buyer must pay to the Seller in Canberra the Balance of the Price by unendorsed bank cheque, or in cash (up to \$200.00).

2.7 Any money payable to the Seller by the Buyer or the Stakeholder must be paid to the Seller or as the Seller Solicitor directs in writing and payment in accordance with that direction will be sufficient discharge to the person paying.

2.8 Completion must take place on the Date for Completion or as otherwise determined by this Contract and if not specified or determined, within a reasonable time.

3. Title to the Lease

- 3.1 The Lease is or will before Completion be granted under the Planning Act.
- 3.2 The Lease is transferred subject to its provisions.
- 3.3 The title to the Lease is or will before Completion be registered under the Land Titles Act.
- 3.4 The title to the Lease must be transferred free from all Affecting Interests except as otherwise provided.
- 3.5 The Buyer cannot insist on any Affecting Interests being removed from the title to the Lease before Completion provided, on Completion, the Seller gives the Buyer any documents and registration fees necessary to remove the Affecting Interests.

4. Restrictions on transfer

- 4.1 The Lease is not subject to any restrictions on transfer other than any Restriction on Transfer.
- 4.2 If the Lease is subject to a Restriction on Transfer under the Planning Act due to non-compliance with the Building and Development Provision then this Contract is subject to the grant of the approval referred to in section 370 of the Planning Act. A Restriction on Transfer referring to “section 370” refers to this restriction.
- 4.3 If the Lease is a lease of the type referred to in section 279 of the Planning Act then this Contract is subject to the approval in accordance with the Planning Act. A Restriction on Transfer referring to “section 280” refers to this restriction.
- 4.3A If the Lease is subject to a Restriction on Transfer under section 306 of the Planning Act, then this Contract is subject to the grant of the approval mentioned in sections 306 and 307 of the Planning Act. A Restriction on Transfer referring to “section 306” refers to this restriction.
- 4.3B If the Lease is subject to a Restriction on Transfer under section 351 of the Planning Act, then this Contract is subject to the grant of the approval mentioned in section 351 of the Planning Act. A Restriction on Transfer referring to “section 351” refers to this restriction. Immediately after the Date of this Contract the Seller must do everything reasonably necessary to remove the restriction or obtain the consent required. If requested in writing, the Buyer must join in any application of the Seller and must do everything reasonably necessary to enable the Seller to obtain the consent. The Seller must pay all associated fees in connection with the application.

- 4.4 If the consent referred to in clauses 4.2, 4.3, 4.3A or 4.3B is not granted by the Date for Completion then either party may rescind this Contract (provided that the party seeking to rescind is not then in default) and clause 21 applies.

5. Particulars of title and submission of transfer

- 5.1 Unless clause 5.3 applies the Seller need not provide particulars of title.
- 5.2 No later than 7 days before the Date for Completion, the Buyer must give the Seller a transfer of the Lease in the form prescribed by the Land Titles Act, to be returned by the Seller to the Buyer on Completion in registrable form.
- 5.3 If the Seller is not the registered proprietor of the Lease at the Date of this Contract, the Seller must give to the Buyer no later than 14 days before the Date for Completion a copy of the instrument and any other documents necessary to enable the Seller to be registered as proprietor.

6. Buyer rights and limitations

- 6.1 If the Buyer establishes before Completion that except as disclosed in this Contract there is any Unapproved Structure on the Property, then the Buyer may:
 - 6.1.1 require the Seller to arrange for the Unapproved Structure to be approved before Completion; and
 - 6.1.2 if the Unapproved Structure is not approved before Completion, rescind or complete and sue the Seller for damages.
- 6.2 If the Buyer establishes, immediately before Completion, that, except as disclosed in this Contract:
 - 6.2.1 the Property is subject to an encumbrance other than the encumbrances shown on the title to the Lease; or
 - 6.2.2 the Buyer is not entitled to vacant possession, then the Buyer may either:
 - 6.2.3 rescind; or
 - 6.2.4 complete and sue the Seller for damages.
- 6.3 The Buyer is not entitled to make any requisitions on the title to the Property.
- 6.4 The Buyer cannot make a claim or objection or rescind or terminate in respect of:
 - 6.4.1 a Service for the Property being a joint service or passing through another property, or any Service for another property passing through the Property;
 - 6.4.2 a wall being or not being a party wall or the Property being affected by an

easement for support or not having the benefit of an easement for support;

- 6.4.3 any change in the Property due to fair wear and tear before Completion;
- 6.4.4 a promise, representation or statement about this Contract, the Property or the Lease, not made in this Contract;
- 6.4.5 any Breach of Covenant described in the Schedule or disclosed elsewhere in this Contract;
- 6.4.6 the ownership or location of any dividing fence;
- 6.4.7 the ownership of any fuel storage tank; and
- 6.4.8 anything disclosed in this Contract (except an Affecting Interest).

7. Seller warranties

7.1 The Seller warrants that at the Date of this Contract:

- 7.1.1 the Seller will be able to complete at Completion;
- 7.1.2 the Seller has no knowledge of any unsatisfied judgment, order or writ affecting the Property;
- 7.1.3 the Seller has no knowledge of any current or threatened claims, notices or proceedings that may lead to a judgment, order or writ affecting the Property; and
- 7.1.4 the Seller is not aware of any material change in the matters disclosed in the Required Documents.

7.2 The Seller warrants that on Completion:

- 7.2.1 the Seller will be or will be able to be the registered proprietor of the Lease and will own the rest of the Property free from any Affecting Interests;
- 7.2.2 the Seller will have the capacity to complete;
- 7.2.3 there will be no unsatisfied judgment, order or writ affecting the Property;
- 7.2.4 the Seller has no knowledge of any current or threatened claims, notices or proceedings that may lead to a judgment, order or writ affecting the Property;
- 7.2.5 the Seller is not aware of any encroachments by or upon the Property except as disclosed. This warranty does not extend to the location of any dividing fence;
- 7.2.6 there will be no Breach of Covenant except as disclosed in this Contract; and
- 7.2.7 unless disclosed in the Schedule or elsewhere in this Contract, the Lease is a

Non-Land Rent Lease and not a Land Rent Lease.

- 7.3 The Seller gives no warranties as to the present state of repair of any of the Improvements or condition of the Land, except as required by law.

8. Adjustments

- 8.1 The Seller is entitled to the Income and is liable for all Land Charges up to and including Completion after which the Buyer will be entitled to the Income and liable for the Land Charges, provided the Seller will be liable for all land tax in respect of the Property if the 'Land Tax to be adjusted?' option on the Schedule is marked 'No'.
- 8.2 The parties must pay any adjustment of the Income and Land Charges calculated under clause 8.1 on Completion.
- 8.3 Any concessional Land Charges must be adjusted on the concessional amount of those Land Charges.
- 8.4 If any of the Land Charges have not been assessed on Completion, the Buyer will be entitled to retain in the Buyer Solicitor trust account from the Balance of the Price an amount sufficient to pay the Seller's proportion of those Land Charges.
- 8.5 Attached are copies of the relevant invoices for the cost of obtaining the Building and Compliance Inspection Report and Pest Inspection Report. The Buyer must pay to the Seller the cost of obtaining the Building and Compliance Inspection Report and the Pest Inspection Report as required by section 18 of the Sale of Residential Property Act on Completion.

9. Terms of possession

- 9.1 The Seller must give the Buyer vacant possession of the Property on Completion unless otherwise marked in the Schedule.
- 9.2 If the Property is sold subject to a tenancy, the Seller has:
 - 9.2.1 attached to this Contract a copy of the signed Tenancy Agreement; or
 - 9.2.2 completed the tenancy summary on page 2 of this Contract.
- 9.3 If the Property is sold subject to a tenancy:
 - 9.3.1 the Seller warrants that except as disclosed in this Contract:
 - (a) if applicable, the rental bond has been provided in accordance with the Residential Tenancies Act;
 - (b) if applicable, the Seller has complied with the Residential Tenancies Act;

- (c) if applicable, the Seller has no notice of any application by the tenant for the release of the rental bond;
- (d) no notices relating to the tenancy have been served on the Seller or any agent of the Seller or on the tenant other than as disclosed in this Contract and there are no outstanding claims or disputes with the tenant;
- (e) there is no unremedied breach of the Tenancy Agreement by the tenant or the Seller; and
- (f) if applicable, the Tenancy Agreement incorporates:
 - (i) the Prescribed Terms; and
 - (ii) any other terms approved by the Residential Tenancies Tribunal.

9.3.2 The Seller must hand to the Buyer on Completion:

- (a) any written Tenancy Agreement to which this Contract is subject;
- (b) a notice of attornment;
- (c) if applicable, any notice required to be signed by the Seller to transfer the rental bond by the Office of Rental Bonds to the Buyer; and
- (d) if applicable, any other notice required to be signed by the Seller under the Residential Tenancies Act.

9.3.3 The Buyer indemnifies the Seller in relation to any liability which the Seller incurs or to which the Seller is subject under the tenancy because of matters occurring after Completion.

10. Inspection and condition of Property

- 10.1 The Buyer may on reasonable notice to the Seller and at reasonable times inspect the Property before Completion.
- 10.2 The Seller must leave the Property clean and tidy on Completion.

11. Inspection of building file

- 11.1 The Seller must, if requested by the Buyer, give to the Buyer all authorities necessary to enable the Buyer (or Buyer's nominee) to inspect and obtain at the Buyer's expense, copies of:
 - 11.1.1 any document in relation to the Land and Improvements held by any government or statutory authority; and

- 11.1.2 any notices issued by any authority in relation to the Land and Improvements.

12. Additional Seller obligations

- 12.1 Except for any Breach of Covenant disclosed in this Contract, the Seller must before Completion:
 - 12.1.1 comply with any notice issued by any authority before the Date of this Contract which requires work to be done or money to be spent on or in relation to the Property or the Lease;
 - 12.1.2 obtain approval for any Development conducted on the Land;
 - 12.1.3 comply with the Lease to the extent to which the Seller is required to comply up to Completion;
 - 12.1.4 comply with any obligations on the Seller in a registered restrictive covenant affecting the Lease; and
 - 12.1.5 give the Buyer notice of any material change (other than fair wear and tear) the Seller becomes aware of in the matters disclosed in the Required Documents, since the date of each of the relevant Required Documents.

13. Electronic transaction

- 13.1 In this clause 13, the following words mean:

Adjustment Figures mean details of the adjustments to be made to the Price under this Contract;

Completion Time means the time of day on the Date for Completion when the Electronic Transaction is to be Completed;

Conveyancing Transaction has the meaning given in the Participation Rules;

Digitally Signed has the meaning given in the Participation Rules and **Digitally Sign** has a corresponding meaning;

Discharging Mortgagee means any discharging mortgagee, chargee, covenant chargee or caveator whose provision of a Digitally Signed discharge of mortgage, discharge of charge or withdrawal of caveat is required in order for unencumbered title to the Lease to be transferred to the Buyer;

ECNL means the *Electronic Conveyancing National Law (ACT) Act 2020 (ACT)*;

Effective Date means the date on which the Conveyancing Transaction is agreed to be an Electronic Transaction under clause 13.2.2 or, if clause 13.2.1 applies, the Date of this Contract;

Electronic Document means a caveat, a Crown lease or an instrument as defined in the Land Titles Act which may be created and Digitally Signed in an Electronic Workspace;

Electronic Transaction means a Conveyancing Transaction to be conducted for the parties by their legal representatives as Subscribers using an ELN and in accordance with the ECNL and the Participation Rules;

Electronic Transfer means a transfer of the Lease under the Land Titles Act to be prepared and Digitally Signed in the Electronic Workspace established for the purposes of the parties' Conveyancing Transaction;

Electronic Workspace has the meaning given in the Participation Rules;

Electronically Tradeable means a land title dealing that can be lodged electronically;

ELN has the meaning given in the Participation Rules;

FRCGW Remittance means a remittance which the Buyer must make in accordance with the Withholding Law and clauses 51.4 to 51.8;

GSTRW Payment means a payment which the Buyer must make in accordance with the Withholding Law and clauses 53.5 to 53.9;

Incoming Mortgagee means any mortgagee who is to provide finance to the Buyer on the security of the Lease and to enable the Buyer to pay the whole or part of the price;

Land Registry has the meaning given in the Participation Rules;

Lodgment Case has the meaning given in the Participation Rules;

Mortgagee Details mean the details which a party to the Electronic Transaction must provide about any Discharging Mortgagee of the Land as at Completion;

Nominated ELN means the ELN specified in the Schedule;

Participation Rules mean the participation rules as determined by the ECNL;

Populate means to complete data fields in the Electronic Workspace;

Prescribed Requirement has the meaning given in the Participation Rules;

Subscribers has the meaning given in the Participation Rules; and

Title Data means the details of the title to the Lease made available to the Electronic Workspace by the Land Registry.

- 13.2 This Conveyancing Transaction is to be conducted as an Electronic Transaction and this Contract is amended as required if:
- 13.2.1 this Contract says that it is an Electronic Transaction; or
- 13.2.2 the parties otherwise agree that it is to be conducted as an Electronic Transaction.
- 13.3 However, this Conveyancing Transaction is not to be conducted as an Electronic Transaction:
- 13.3.1 if the title to the Lease is not Electronically Tradeable or the transfer of the Lease is not eligible to be lodged electronically; or
- 13.3.2 if, at any time after the Effective Date, but at least 14 days before the Date for Completion, a party serves a notice on the other party stating a valid reason why it cannot be conducted as an Electronic Transaction.
- 13.4 If, because of clause 13.3.2, this Conveyancing Transaction is not to be conducted as an Electronic Transaction:
- 13.4.1 each party must:
- (a) bear equally any disbursements or fees; and
- (b) otherwise bear that party's own costs; incurred because this Conveyancing Transaction was to be conducted as an Electronic Transaction; and
- 13.4.2 if a party has paid all of a disbursement or fee which by reason of this clause, is to be borne equally by the parties, that amount must be adjusted on Completion.
- 13.5 If this Conveyancing Transaction is to be conducted as an Electronic Transaction:
- 13.5.1 to the extent that any other provision of this Contract is inconsistent with this clause, the provisions of this clause prevail and this Contract is amended to give full effect to the Electronic Transaction;
- 13.5.2 without limiting clause 13.5.1, clause 5.2 does not apply;
- 13.5.3 the parties must conduct the Electronic Transaction:
- (a) in accordance with the Participation Rules and the ECNL; and
- (b) using the Nominated ELN, unless the parties otherwise agree;
- 13.5.4 a party must pay the fees and charges payable by that party to the ELN and the

- Land Registry as a result of this transaction being an Electronic Transaction; and
- 13.5.5 a document which is an Electronic Document is served as soon as it is first Digitally Signed in the Electronic Workspace on behalf of the party required to serve it.
- 13.6 The Seller must within 7 days of the Effective Date:
- 13.6.1 create an Electronic Workspace;
- 13.6.2 Populate the Electronic Workspace with Title Data, the Date for Completion and, if applicable, Mortgagee Details; and
- 13.6.3 invite the Buyer and any Discharging Mortgagee to the Electronic Workspace.
- 13.7 If the Seller has not created an Electronic Workspace in accordance with clause 13.6, the Buyer may create an Electronic Workspace. If the Buyer creates the Electronic Workspace the Buyer must:
- 13.7.1 Populate the Electronic Workspace with Title Data;
- 13.7.2 create and Populate the Electronic Transfer;
- 13.7.3 Populate the Electronic Workspace with the Date for Completion and a nominated Completion Time; and
- 13.7.4 invite the Seller and any Incoming Mortgagee to join the Electronic Workspace.
- 13.8 Within 7 days of receiving an invitation from the Seller to join the Electronic Workspace, the Buyer must:
- 13.8.1 join the Electronic Workspace;
- 13.8.2 create and Populate the Electronic Transfer;
- 13.8.3 invite any Incoming Mortgagee to join the Electronic Workspace; and
- 13.8.4 Populate the Electronic Workspace with a nominated Completion Time.
- 13.9 If the Buyer has created the Electronic Workspace the Seller must within 7 days of being invited to the Electronic Workspace:
- 13.9.1 join the Electronic Workspace;
- 13.9.2 Populate the Electronic Workspace with Mortgagee Details, if applicable; and
- 13.9.3 invite any Discharging Mortgagee to join the Electronic Workspace.
- 13.10 To complete the financial settlement schedule in the Electronic Workspace:
- 13.10.1 the Seller must provide the Buyer with Adjustment Figures at least 2 Business Days before the Date for Completion;
- 13.10.2 the Buyer must confirm the Adjustment Figures at least 1 Business Day before the Date for Completion; and
- 13.10.3 if the Buyer must make a GSTRW Payment and / or an FRCGW Remittance, the Buyer must Populate the Electronic Workspace with the payment details for the GSTRW Payment or FRCGW Remittance payable to the ATO at least 2 Business Days before the Date for Completion.
- 13.11 Before Completion, the parties must ensure that:
- 13.11.1 all Electronic Documents which a party must Digitally Sign to complete the Electronic Transaction are Populated and Digitally Signed;
- 13.11.2 all certifications required by the ECNL are properly given; and
- 13.11.3 they do everything else in the Electronic Workspace which that party must do to enable the Electronic Transaction to proceed to Completion.
- 13.12 If Completion takes place in the Electronic Workspace:
- 13.12.1 payment electronically on Completion of the Balance of the Price in accordance with clause 2.6 is taken to be payment by a single unendorsed bank cheque; and
- 13.12.2 clauses 51.4.3, 51.4.4, 53.8 and 53.9 do not apply.
- 13.13 If the computer systems of any of the Land Registry, the ELN, the ATO or the Reserve Bank of Australia are inoperative for any reason at the Completion Time agreed by the parties, a failure to complete this Contract for that reason is not a default under this Contract on the part of either party.
- 13.14 If the computer systems of the Land Registry are inoperative for any reason at the Completion Time agreed by the parties, and the parties agree that financial settlement is to occur despite this, then on financial settlement occurring:
- 13.14.1 all Electronic Documents Digitally Signed by the Seller, any discharge of mortgage, withdrawal of caveat or other Electronic Document forming part of the Lodgment Case for the Electronic Transaction shall be taken to have been unconditionally and irrevocably delivered to the Buyer or

the Buyer's mortgagee at the time of financial settlement; and

13.14.2 the Seller shall be taken to have no legal or equitable interest in the Property.

13.15 If the parties do not agree about the delivery before Completion of one or more documents or things that cannot be delivered through the Electronic Workspace, the party required to deliver the documents or things:

13.15.1 holds them on Completion in escrow for the benefit of the other party; and

13.15.2 must immediately after Completion deliver the documents or things to, or as directed by the party entitled to them.

14. Off the plan purchase and Compliance Certificate

14.1 If the Lease contains a Building and Development Provision which has not been complied with at the Date of this Contract, and clause 4.2 does not apply:

14.1.1 where the Seller is obliged to construct Improvements by Completion, before the Date for Completion, the Seller must at the Seller's expense complete the construction of the Improvements promptly and in a good and workmanlike manner substantially in accordance with the proposed plan, specifications and inclusions list attached; and

14.1.2 on or before Completion, the Seller must at the Seller's expense give to the Buyer evidence that a Compliance Certificate has been obtained.

15. Goods

15.1 The Seller gives no warranties as to the present state of repair of any of the Goods except as required by law.

15.2 The Goods are included in the Price.

15.3 The Seller warrants that the Goods are unencumbered and that the Seller has the right to sell them.

15.4 The Goods become the Buyer's property on Completion.

15.5 Except for fair wear and tear, the Seller must give the Goods to the Buyer on Completion in the same state of repair they are in at the Date of this Contract.

16. Errors and misdescriptions

16.1 If, before Completion, the Buyer becomes aware of an error in the description of the Property the Buyer may:

16.1.1 identify whether the error is material or not material, and ask the Seller to arrange for the error to be corrected before Completion; and

16.1.2 if the error is not corrected before Completion:

(a) for an error that is material — rescind this Contract, or complete this Contract and make a claim for compensation; and

(b) for an error that is not material — complete this Contract and make a claim for compensation.

16.2 This clause applies even if the Buyer did not take notice of or rely on anything in this Contract containing or giving rise to the error or misdescription.

16.3 The Buyer is not entitled to compensation to the extent the Buyer knew the true position before the Date of this Contract.

17. Compensation claims by Buyer

17.1 To make a claim for compensation (including a claim under clause 16) the Buyer must give notice to the Seller before Completion specifying the amount claimed and:

17.1.1 the Seller can rescind if in the case of a claim that is not a claim for delay:

(a) the total amount claimed exceeds 5% of the Price;

(b) the Seller gives notice to the Buyer of an intention to rescind; and

(c) the Buyer does not give notice to the Seller waiving the claim within 14 days after receiving the notice; and

17.1.2 if the Seller does not rescind under clause 17.1.1, the parties must complete and:

(a) the lesser of the total amount claimed and 5% of the Price must be paid out of the Price to, and held by, the Stakeholder until the claim is finalised or lapses;

(b) the amount held is to be invested by the Stakeholder (at the risk of the party who becomes entitled to it) with an Australian bank in an interest-bearing account at call in the name of

- the Stakeholder in trust for the Seller and the Buyer;
 - (c) the claim must be finalised by an arbitrator appointed by the parties or, if an appointment is not made within 28 days of Completion, by an arbitrator appointed by the President of the Law Society of the Australian Capital Territory at the request of a party;
 - (d) the decision of the arbitrator is final and binding;
 - (e) the costs of the arbitration must be shared equally by the parties unless otherwise determined by the arbitrator. For clarity, the arbitrator has the power to award indemnity costs on a legal basis against either party;
 - (f) the Buyer is not entitled, in respect of the claim, to more than the total amount claimed and the costs of the Buyer;
 - (g) interest on the amount held, after deduction of all taxes and bank charges, Stakeholder administration fee and other similar charges and expenses, must be paid to the parties equally or as otherwise determined by the arbitrator; and
 - (h) the claim lapses if the parties do not appoint an arbitrator and neither party asks the President of the Law Society of the Australian Capital Territory to appoint an arbitrator within 90 days after Completion and the amount held by the Stakeholder must be paid immediately to the Seller without any further authority being necessary.
- 18.3.2 be ready willing and able to complete but for some default or omission of the other party.
- 18.4 Completion at the time date and place specified in the Notice to Complete is an essential term.
- 18.5 Where one party is in default (other than failing to complete) the other party may at any time after the default serve the party in default a Default Notice.
- 18.6 A Default Notice:
- 18.6.1 must specify the default;
 - 18.6.2 must require the party served with the Default Notice to rectify the default within 7* days after service of the Default Notice (excluding the date of service), except in the case of a Default Notice for the purposes of clause 52.6, in which case the period specified in clause 52.6 will apply; and
 - 18.6.3 cannot be used to require a party to complete this Contract.
- 18.7 At the time the Default Notice is served, the party serving the Default Notice must not be in default.
- 18.8 The time specified in a Default Notice to rectify the specified default is an essential term.
- 18.9 Clauses 19 or 20 will apply as appropriate where the party served does not comply with the Notice to Complete or the Default Notice which complies with this clause.
- 18.10 If the party serving a notice under this clause varies the time referred to in the notice at the request of the other party, the time agreed to in the variation remains an essential term. The consent to the variation must be in writing and be served on the other party.
- 18.11 The parties agree that the time referred to in clauses 18.2 and 18.6.2 is fair and reasonable.

18. Notice to Complete and Default Notice

- 18.1 If Completion does not take place in accordance with clause 2.8, either party may, at any time after the Date for Completion, serve the other party a Notice to Complete.
- 18.2 A Notice to Complete must appoint a time during business hours and a date being not less than 14* days after service of the Notice to Complete (excluding the date of service) by which and a place in Canberra at which to complete this Contract.
- 18.3 At the time the Notice to Complete is served the party serving the Notice to Complete must:
- 18.3.1 not be in default; and

19. Termination — Buyer default

- 19.1 If the Buyer does not comply with a Notice to Complete or a Default Notice or is otherwise in breach of an essential term then the Seller may by notice served on the Buyer terminate and may then keep, or recover and keep, the Deposit (except so much of it as exceeds 10% of the Price) and either:
- 19.1.1 sue the Buyer for breach; or
 - 19.1.2 resell the Property and any deficiency arising on the resale and all expenses of and incidental to the resale or attempted resale and the Buyer's default are

* Alter as necessary

recoverable by the Seller from the Buyer as liquidated damages provided the Seller has entered into a contract for the resale of the Property within 12 months of termination.

- 19.2 In addition to any money kept or recovered under clause 19.1, the Seller may retain on termination any other money paid by the Buyer as security for any damages awarded to the Seller arising from the Buyer's default provided that proceedings for the recovery of damages are commenced within 12 months of termination.

20. Termination – Seller default

- 20.1 If the Seller does not comply with a Notice to Complete or a Default Notice or is otherwise in breach of an essential term the Buyer may by notice served on the Seller either:

- 20.1.1 terminate and seek damages; or
- 20.1.2 enforce without further notice any other rights and remedies available to the Buyer.

- 20.2 If the Buyer terminates, the Stakeholder is authorised to refund to the Buyer immediately any money paid on account of the Price.

21. Rescission

- 21.1 Unless section 15 of the Sale of Residential Property Act applies, if this Contract is rescinded, it is rescinded from the beginning, and unless the parties otherwise agree:

- 21.1.1 the Deposit and all other money paid by the Buyer must be refunded to the Buyer immediately without any further authority being necessary; and
- 21.1.2 neither party is liable to pay the other any amount for damages, costs or expenses.

22. Damages for delay in Completion

- 22.1 If Completion does not occur by the Date for Completion, due to the default of either party, the party who is at fault must pay the other party as liquidated damages on Completion:

- 22.1.1 if the defaulting party is the Seller, interest on the Price at the rate this Contract says on page 2, calculated on a daily basis from the date 7 days after the Date for Completion to Completion;
- 22.1.2 if the defaulting party is the Buyer, interest on the Price at the rate this Contract says on page 2, calculated on a daily basis from the date 7 days after the Date for Completion to Completion; and
- 22.1.3 the amount this Contract says on page 2 to be applied towards any legal costs and disbursements incurred by the party not

at fault if Completion occurs later than 7 days after the Date for Completion.

- 22.2 Whether or not percentages are inserted in clauses 22.1.1 or 22.1.2 the party at fault must pay the amount specified in clause 22.1.3 in addition to any other damages to which the party not at fault is entitled both at law and under this Contract.

- 22.3 The parties agree that:

- 22.3.1 the amount of any damages payable under clause 22.1.1 or clause 22.1.2 to the party not in default is a genuine and honest pre-estimate of loss to that party for the delay in Completion, and
- 22.3.2 the damages must be paid on Completion.

23. Foreign Buyer

- 23.1 The Buyer warrants the Commonwealth Treasurer cannot prohibit and has not prohibited the transfer of the Lease under the *Foreign Acquisitions and Takeovers Act 1975* (Cth).

- 23.2 This clause is an essential term.

24. GST

- 24.1 If a party must pay the Price or provide any other consideration to another party under this Contract, GST is not to be added to the Price or amount, unless this Contract provides otherwise.

- 24.2 If the Price is stated in the Schedule to exclude GST and the sale of the Property is a taxable supply, the Buyer must pay to the Seller on Completion an amount equal to the GST payable by the Seller in relation to the supply.

- 24.3 If under this Contract a party (Relevant Party) must make an adjustment, pay an amount to another party (excluding the Price but including the Deposit if it is released or forfeited to the Seller) or pay an amount payable by or to a third party:

- 24.3.1 the Relevant Party must adjust or pay at that time any GST added to or included in the amount; but
- 24.3.2 if this Contract says this sale is a taxable supply, and payment would entitle the Relevant Party to claim an input tax credit, the adjustment or payment is to be worked out by deducting any input tax credit to which the party receiving the adjustment or payment is or was entitled multiplied by the GST Rate.

- 24.4 If this Contract says this sale is the supply of a going concern:

- 24.4.1 the parties agree the supply of the Property is the supply of a going concern;
 - 24.4.2 the Seller must on Completion supply to the Buyer all of the things that are necessary for the continued operation of the enterprise;
 - 24.4.3 the Seller must carry on the enterprise until Completion;
 - 24.4.4 the Buyer warrants to the Seller that on Completion the Buyer will be registered or required to be registered; and
 - 24.4.5 if for any reason (and despite clauses 24.1 and 24.4.1) the sale of the Property is not the supply of a going concern but is a taxable supply:
 - (a) the Buyer must pay to the Seller on demand the amount of any GST payable by the Seller in respect of the sale of the Property; and
 - (b) the Buyer indemnifies the Seller against any loss or expense incurred by the Seller in respect of that GST and any breach of clause 24.4.5(a).
- 24.5 If this Contract says the margin scheme applies:
- 24.5.1 the Seller warrants that it can use the margin scheme; and
 - 24.5.2 the Buyer and Seller agree that the margin scheme is to apply,
- in respect of the sale of the Property.
- 24.6 If this Contract says the sale is a taxable supply, does not say the margin scheme applies to the sale of the Property, and the sale is in fact not a taxable supply, then the Seller must pay the Buyer on Completion an amount of one-eleventh of the Price.
- 24.7 Unless the margin scheme applies the Seller must, on Completion, give the Buyer a tax invoice for any taxable supply by the Seller by or under this Contract.

25. Power of attorney

- 25.1 Any party who signs this Contract or any document in connection with it under a power of attorney must, on request and without cost, provide the other party with a true copy of the registered power of attorney.

26. Notices claims and authorities

- 26.1 Notices, claims and authorities required or authorised by this Contract must be in writing.
- 26.2 To serve a notice a party must:
 - 26.2.1 leave it at; or

- 26.2.2 send it by a method of post requiring acknowledgment of receipt by the addressee to,
the address of the person to be served as stated in the Schedule or as notified by that person to the other as that person's address for service under this Contract; or
 - 26.2.3 serve it on that party's solicitor in any of the above ways; or
 - 26.2.4 deliver it to an appropriate place in the facilities of a document exchange system in which the recipient solicitor has receiving facilities (and in the latter case service is deemed effected on the Business Day following delivery); or
 - 26.2.5 transmit it by email to a party's solicitor to the email address for that solicitor as stated in the Schedule or as notified by that solicitor to the other solicitor as the email address for service under this Contract.
- 26.3 A party's solicitor may give a notice, claim or authority on behalf of that party.

27. Unit title

- 27.1 The following clauses 28 to 39 inclusive apply if the Property is a Unit.

28. Definitions and interpretation

- 28.1 A reference in these clauses 28 to 39 inclusive to a section or Part is a reference to a section or Part of the Unit Titles Management Act.
- 28.2 For the purposes of a claim for compensation pursuant to clause 39, the provisions of clause 17 will apply provided that clause 17.1.1(c) is amended to read "the Buyer does not give notice to the Seller waiving the claim, or so much of it as exceeds 5% of the Price within 14 days after receiving the notice".

29. Title to the Unit

- 29.1 Clauses 3.1, 3.2 and 3.3 do not apply.
- 29.2 The Unit Title is or will before Completion be granted under the Planning Act and is or will before Completion be registered under the *Land Titles (Unit Titles) Act 1970* (ACT).
- 29.3 The Unit Title is transferred subject to the Units Plan under which the lease to the Unit is held.

30. Buyer rights limited

- 30.1 In addition to clause 6, the Buyer cannot make any requisition on title or make a claim for compensation in respect of any Breach of Covenant of the Unit Title, any breach of the

lease of the Common Property or breach of rules of the Owners Corporation disclosed in this Contract.

31. Adjustment of contribution

31.1 Any adjustment under clause 8 must include an adjustment of the contributions to the Owners Corporation under section 78 and section 89 of the Unit Titles Management Act.

32. Inspection of Unit

32.1 For the purposes of clause 10.1 Property includes the Common Property.

33. Seller warranties

33.1 The Seller warrants that at the Date of this Contract:

33.1.1 to the Seller's knowledge, there are no unfunded latent or patent defects in the Common Property or Owners Corporation assets, other than the following:

- (a) defects arising through fair wear and tear; and
- (b) defects disclosed in this Contract;

33.1.2 the Owners Corporation records do not disclose any defects to which the warranty in clause 33.1.1 applies;

33.1.3 to the Seller's knowledge, there are no actual, contingent or expected unfunded liabilities of the Owners Corporation that are not part of the Owners Corporation's normal operating expenses, other than liabilities disclosed in this Contract;

33.1.4 the Owners Corporation records do not disclose any liabilities of the Owners Corporation to which the warranty in clause 33.1.3 applies;

33.1.5 the Seller or any occupier of the Unit has not committed any act or omission which may cause the Owners Corporation to incur any costs or perform any repairs;

33.1.6 there is no amount payable to the Owners Corporation by the Seller other than a contribution due under section 78 and section 89 of the Unit Titles Management Act; and

33.1.7 except for an unregistered Units Plan, the rules of the Owners Corporation are, as appropriate:

- (a) as set out in Schedule 4 to the Unit Titles Management Act; or

(b) in respect of a corporation established under the *Unit Titles Act 1970* (*repealed*) and that was in existence immediately prior to 30 March 2012, the articles in force immediately prior to 30 March 2012; or

(c) in respect of a corporation established under the Unit Titles Act and that was in existence immediately prior to 30 March 2012, the articles in force immediately prior to 30 March 2012;

except for any alterations to those rules registered under section 108.

33.2 For clauses 33.1.1 to 33.1.4 inclusive, a Seller is taken to have knowledge of a thing if the Seller has actual knowledge, or ought reasonably to have knowledge, of that thing.

33.3 The Seller warrants that at Completion to the Seller's knowledge, there are no circumstances (other than circumstances disclosed in this Contract) in relation to the affairs of the Owners Corporation likely to significantly prejudice the Buyer.

33.4 For the purposes of clause 7, Property includes the Common Property.

33.5 These warranties are in addition to those given in clause 7.

34. Damage or destruction before Completion

34.1 If the Unit is destroyed or substantially damaged before Completion not due to the fault of either party then either party may by notice to the other rescind and clause 21 applies.

34.2 For the purposes of clause 34.1, the Unit is deemed to be substantially damaged if though not destroyed is unfit for the use to which it was being put at the Date of this Contract or, if not being used at that time, for the purpose permitted by the Unit Title.

35. Notice to Owners Corporation

35.1 The parties must comply with the rules of the Owners Corporation in relation to notification of the sale and purchase of the Unit.

36. Unit Title Certificate

36.1 On Completion the Buyer must pay to the Seller the fee as determined by the Minister pursuant to section 119(7) of the Units Title Management Act for the Unit Title Certificate attached.

37. Unregistered Units Plan

Warning: The following clauses 37, 38 and 39 do not encompass all obligations, rights and remedies under Part 2.9 of the Property Act for off the plan contracts.

- 37.1 This clause 37 applies if at the Date of this Contract, the Units Plan has not been registered.
- 37.2 The Seller must attach a copy of the proposed Units Plan or a sketch plan showing the location and dimensions of the Unit sufficient to enable the Buyer to determine the location and dimensions of the Unit in relation to other units and the Common Property in the proposed development.
- 37.3 If the Units Plan is not registered by the date specified in the Schedule, or elsewhere in this Contract, the Buyer may at any time after that date by notice served on the Seller require that the Units Plan be registered within 14 days of the service of the notice. If the Units Plan is not registered within the time limited by the notice the Buyer may at any time after expiry of the time in the notice rescind and clause 21 will apply.
- 37.4 If the Seller notifies the Buyer that the Units Plan is registered before rescission under this clause, the Buyer will not be entitled to rescind under this clause.
- 37.5 The Buyer cannot make any objection or requisition on title or claim for compensation in respect of:
- 37.5.1 any minor variations to the Unit between the plan attached, and the Units Plan registered by the Registrar General; or
- 37.5.2 any minor alterations required by an authority or the Registrar General in the number, size, location or Unit Entitlement of any other unit in the Units Plan or in or to the Common Property provided the proportion of the Unit Entitlement of the Unit to the other units in the Units Plan is not varied.
- In this clause, a minor variation is any variation less than 5% to either the size or value of the Unit described in the plan attached.
- 37.6 After the Owners Corporation has been constituted under section 8, the Seller must cause the Owners Corporation to comply with the rules of the Owners Corporation and with Parts 2, 3, 4, 5 and 7 to the extent to which the Owners Corporation is required by law to comply with those provisions up to the Date for Completion.
- 37.7 The Seller must not permit the Owners Corporation to vary the rules of the Owners

Corporation from those set out in Schedule 4 of the Unit Title Management Act.

- 37.8 If clause 37.1 applies, the Seller must give to the Buyer a Unit Title Certificate at the Buyer's expense at least 7 days before Completion.
- 37.9 The parties acknowledge that the following must form part of the Contract:
- 37.9.1 a Disclosure Statement for the Unit that complies with the requirements of section 260 of the Property Act; and
- 37.9.2 if a right to approve the keeping of animals during the Developer Control Period is reserved — details of the reservation, including the kind and number of animals.
- 37.10 The Seller warrants that the information disclosed in the Disclosure Statement, including information in any Disclosure Update Notice, is accurate.

38. Rescission of Contract

- 38.1 The Buyer may, by written notice given to the Seller, rescind this Contract if:
- 38.1.1 there would be a breach of a warranty provided in any of clauses 33.1.1, 33.1.2, 33.1.3, 33.1.4 or 33.3, were this Contract completed at the time it is rescinded; or
- 38.1.2 there would be a breach of a warranty provided in clause 37.10:
- (a) were this Contract completed at the time it is rescinded; and
- (b) the Buyer is significantly prejudiced by the breach,
- and the breach does not relate to an amendment to the Development Statement that is an Excluded Change.
- 38.2 A notice must be given:
- 38.2.1 under clause 38.1.1:
- (a) if this Contract is entered before the Units Plan for the Unit is registered — not later than 3 days before the Buyer is required to complete this Contract; or
- (b) in any other case — not later than 14 days after the later of the following happens:
- (i) the Date of this Contract; and
- (ii) another period agreed between the Buyer and Seller ends; or

38.2.2 under clause 38.1.2 – at any time before the Buyer is required to complete this Contract.

38.3 If the Buyer rescinds this Contract, the Seller must repay any amount paid to the Seller towards the purchase of the Unit and otherwise the provisions of clause 21 will apply.

39. Claims for compensation

39.1 This clause 39 applies if, before Completion, the Buyer reasonably believes that, except as disclosed in this Contract, there would be a breach of a warranty established under any of clauses 33.1.1, 33.1.2, 33.1.3, 33.1.4, 33.3 or 37.10 were this Contract to be completed.

39.2 The Buyer may, by written notice given to the Seller:

39.2.1 tell the Seller:

- (a) about the breach; and
- (b) that the Buyer will complete this Contract; and

39.2.2 claim compensation for the breach.

39.3 A notice under clause 39.2 must be given:

39.3.1 if this Contract is entered before the Units Plan for the Unit is registered – not later than 3 days before the Buyer is required to complete this Contract; or

39.3.2 in any other case – not later than 14 days after the later of the following happens:

- (a) the Buyer's copy of the Contract is received by the Buyer;
- (b) another period agreed between the Buyer and Seller ends.

39.4 The Buyer may not claim compensation under this clause 39 only because of the breach of a warranty related to an amendment to the Development Statement that is an Excluded Change.

40. Community title

40.1 The following clauses 41 to 50 inclusive apply if the Property is, or will on Completion form, a Lot within a Community Title Scheme.

41. Definitions and interpretation

41.1 A reference in these clauses 40 to 50 inclusive to a section or Part is a reference to a section or Part of the Community Title Act.

42. Buyer rights limited

42.1 In addition to clause 6, the Buyer cannot make any requisition on title or make a claim for

compensation in respect of any breach of the lease of the Common Property or breach of rules or by-laws of the Community Title Body Corporate disclosed in this Contract.

43. Adjustment of contribution

43.1 Any adjustment under clause 8 must include an adjustment of the contributions to the fund under section 45.

44. Inspection of property

44.1 For the purposes of clause 10.1 Property includes the Common Property.

45. Unregistered Community Title Scheme

45.1 This clause 45 applies if at the Date of this Contract, the Community Title Scheme has not registered.

45.2 The Seller must attach a copy of the proposed Community Title Master Plan, or a sketch plan showing the location and dimensions of the Lot sufficient to enable the Buyer to determine the location and dimensions of the Lot in relation to other lots and the Common Property in the proposed scheme.

45.3 The Seller must attach a copy of the proposed Community Title Management Statement.

45.4 The Buyer cannot make any objection or requisition on title or claim for compensation in respect of:

45.4.1 any minor variations to the Lot between the plan attached, and the registered Community Title Master Plan; or

45.4.2 any minor alterations required by an authority or the Registrar General in the number, size, location or entitlement of any other Lot in the Community Title Scheme or in or to the Common Property provided the proportion of the entitlement of the Lot to the other lots in the Community Title Scheme is not varied; or

45.4.3 any minor variations between the proposed Community Title Management Statement and the registered Community Title Management Statement.

In this clause, a minor variation is any variation less than 5% to either the size or value of the Lot described in the plan attached and referred to in the proposed Community Title Management Statement.

45.5 The Seller must not permit the Community Title Body Corporate to vary the by-laws of the

Community Title Scheme from those set out in Schedule 1 of the Community Title Act, unless otherwise disclosed in this Contract.

- 45.6 After the Community Title Body Corporate has been constituted under section 30, the Seller must cause the Community Title Body Corporate to comply with Part 8 to the extent to which the Community Title Body Corporate is required by law to comply with those provisions up to the Date for Completion.

46. Incomplete development of Community Title Scheme

- 46.1 This clause 46 applies if at the Date of this Contract, development of the Community Title Scheme has not completed.
- 46.2 Until the development of a Community Title Scheme is finished, the Developer warrants to the Buyer that the development will be carried out in accordance with the scheme.
- 46.3 Without limiting the damages recoverable for breach of the warranty in clause 46.2, the Buyer may recover damages for the loss of a reasonably expected capital appreciation of the Lot that would have resulted from completion of the development in accordance with the terms of the Community Title Scheme.

47. Incomplete development of Lot

- 47.1 This clause 47 applies if at the Date of this Contract, the Lot is to be developed or further developed in accordance with the Community Title Scheme. For clarity, this clause does not apply if an unconditional Compliance Certificate has issued before the Date of this Contract and the Seller gives to the Buyer evidence acceptable to the Registrar General that an unconditional Compliance Certificate has issued for the Lot, or if the Seller gives an unconditional Compliance Certificate to the Buyer on Completion.
- 47.2 The Buyer becomes bound to develop the Lot in accordance with the Community Title Scheme.
- 47.3 The Seller must give written notice of the proposed sale of the Lot to the Planning and Land Authority.
- 47.4 The Buyer must:
- 47.4.1 give to the Planning and Land Authority a written undertaking to develop the Lot in accordance with the Community Title Scheme (if a form is approved for an undertaking, the form must be used); and
 - 47.4.2 give the Planning and Land Authority any security required by the Planning and Land Authority, within 28 days after notice of the transaction was given to the

Planning and Land Authority, for the development of the Lot in accordance with the Community Title Scheme.

48. Required first or top sheet

- 48.1 The Seller must give to the Buyer, before the Buyer enters into this Contract, a Section 67 Statement.
- 48.2 The Section 67 Statement must:
- 48.2.1 state that the Lot is included in a Community Title Scheme that imposes obligations on the owner of the Lot;
 - 48.2.2 state the name and address of:
 - (a) the body corporate of the scheme; or
 - (b) if it is the duty of the Community Title Body Corporate manager to act for the Community Title Body Corporate in supplying Section 56 Certificates – the manager;
 - 48.2.3 state the amount of annual contributions currently fixed by the Community Title Body Corporate as payable by the owner of the Lot;
 - 48.2.4 identify improvements on common property of the scheme for which the owner of the Lot is responsible;
 - 48.2.5 be signed by the Seller or a person authorised by the Seller; and
 - 48.2.6 be substantially complete.
- 48.3 The Seller must attach to this Contract, as a first or top sheet, a copy of the Section 67 Statement given to the Buyer under clause 48.1.
- 48.4 The Buyer may rescind this Contract if:
- 48.4.1 the Seller has not complied with clauses 48.1 and 48.3; and
 - 48.4.2 Completion has not taken place.

49. Notice to Community Title Body Corporate

- 49.1 The parties must comply with the rules and by-laws of the Community Title Body Corporate in relation to notification of the sale and purchase of the Lot.

50. Section 56 Certificate

- 50.1 The Seller must give to the Buyer a Section 56 Certificate at least 7 days before Completion.
- 50.2 On Completion, the Buyer must pay to the Seller the fee charged for the Section 56 Certificate.

51. Foreign Resident Withholding Tax

Warning: The questions in the Schedule regarding the Relevant Price and the Clearance Certificates are not binding, and are included to remind the parties of their obligations under the Withholding Law.

Warning: The following clauses 51.1 to 51.8 are subject to the Withholding Law, and do not encompass all obligations under the Withholding Law.

51.1 In this clause 51 the following words have the following meanings:

CGT Asset has the meaning in the *Income Tax Assessment Act 1997*;

Clearance Certificate means a certificate issued under section 14-220 of the Withholding Law that covers the date of Completion;

Relevant Percentage means the percentage amount stated in section 14-200(3)(a) and 14-205(4)(a) of the Withholding Law;

Relevant Price means the higher of:

- the Price (including GST); and
- the market value of the CGT Assets sold under this Contract;

as at the Date of this Contract;

Variation Certificate means a certificate issued under section 14-235 of the Withholding Law that covers the date of Completion;

Withholding Amount means, subject to clauses 51.6 and 51.7, the Relevant Percentage of the first element of the CGT Asset's cost base (for all CGT Assets sold under this Contract) as at the Date of this Contract; and

Withholding Law means Subdivision 14-D of Schedule 1 of the *Taxation Administration Act 1953* and associated provisions.

51.2 If the Relevant Price is less than the dollar amount stated in section 14-215(1)(a) of the Withholding Law as at the Date of this Contract, the parties acknowledge that there are no obligations under the Withholding Law.

51.3 If Clearance Certificates for all the Sellers are provided to the Buyer prior to Completion, the parties acknowledge that there are no obligations under the Withholding Law.

51.4 If neither clauses 51.2 or 51.3 apply, then:

51.4.1 the Seller must provide to the Buyer any information required to enable the Buyer to comply with clause 51.4.2(a), within 5 days of written request from the Buyer;

51.4.2 the Buyer must:

(a) lodge a purchaser payment notification form with the ATO; and

(b) give evidence of compliance with clause 51.4.2(a) to the Seller;

no later than 5 days before the Date for Completion;

51.4.3 the Seller irrevocably instructs the Buyer to draw as part of the Price, and the Buyer must draw and retain on Completion, an unendorsed bank cheque payable to the ATO for the Withholding Amount; and

51.4.4 the parties must both, on the date of Completion, attend the offices of an authorised collection agent of the ATO to deposit the bank cheque referred to in clause 51.4.3 in payment of the Withholding Amount following Completion.

51.5 If clause 51.4 applies and the parties do not comply with clause 51.4.4:

51.5.1 the Buyer indemnifies the Seller for any loss or damage resulting from the Buyer's delay in remitting and/or failure to remit the Withholding Amount to the ATO; and

51.5.2 the Buyer charges the Property (for the benefit of the Seller) with the Buyer's obligations under this clause 51.5.

51.6 Where the Seller gives the Buyer a Variation Certificate prior to Completion, the Withholding Amount is the amount stated in the Variation Certificate.

51.7 Where Clearance Certificates for some but not all of the Sellers are provided to the Buyer prior to Completion, then the Withholding Amount is reduced by the same percentage as the percentage ownership of the Property of the Sellers that are subject to a Clearance Certificate.

51.8 Where a Clearance Certificate is provided by a Seller to the Buyer, the Seller warrants to the Buyer that that Seller is the entity referred to in the Clearance Certificate and is the relevant taxpayer for capital gains tax payable on the sale of the CGT Assets sold under this Contract.

52. Deposit by Instalments

52.1 The following clauses 52.2 to 52.8 inclusive only apply if the 'Deposit by Instalments' option on the Schedule is selected.

52.2 Clauses 2.1, 2.2, 2.3 and 2.4 are deleted.

52.3 The Buyer must pay the Deposit to the Stakeholder. The Seller agrees to accept the payment of the Deposit in two instalments as follows:

52.3.1 5% of the Price by cheque on the Date of this Contract (**First Instalment**); and

52.3.2 the balance of the Deposit (if it has not already been paid) by unendorsed bank cheque on the Date for Completion (**Second Instalment**);

and in every respect time is of the essence for payment of the First Instalment in this clause 52.3.1.

52.4 The Deposit becomes the Seller's property on Completion or on the earlier termination of this Contract by the Seller for the Buyer's default.

52.5 If the First Instalment of the Deposit is:

52.5.1 not paid on time and in accordance with clause 52.3; or

52.5.2 paid by cheque and the cheque is not honoured on first presentation,

the Buyer is in default and the Seller may terminate this Contract immediately by written notice to the Buyer (without the notice otherwise necessary under clause 18) and clause 19 applies. If the Seller does not terminate this Contract in accordance with this clause 52.5, then this Contract remains on foot, subject to this clause 52.5, until either the Seller terminates the Contract pursuant to this clause 52.5, or waives the benefit of this clause 52.5 pursuant to clause 52.8.

52.6 If the Second Instalment of the Deposit is not paid on time in accordance with clause 52.3, then the Seller cannot immediately terminate the Contract for the Buyer's breach of an essential condition. The Seller must make timing of the payment of the Second Instalment an essential condition of the Contract by serving on the Buyer a Default Notice requiring the Buyer to pay the Second Instalment within 14* days after service of the Default Notice (excluding the date of service).

52.7 For clarity, the Buyer must pay the full Price to the Seller, on or before Completion.

52.8 These clauses 52.2 to 52.8 inclusive are for the benefit of the Seller. The Seller may at any time before this Contract is terminated notify the Buyer in writing that the benefit of these clauses 52.2 to 52.8 inclusive is waived.

53. Residential Withholding Tax

Warning: The following clauses 53.1 to 53.9 are subject to the Withholding Law, and do not encompass all obligations under the Withholding Law.

53.1 In this clause 53 the following words have the following meanings:

RW Amount means the amount which the Buyer must pay under section 14-250 of the Withholding Law;

RW Amount Information means the completed RW Amount details referred to on page 3 of this Contract; and

RW Percentage means the percentage amount stated in section 14-250(6), (8) and (9) of the Withholding Law, as applicable to the supply of the Property from the Seller to the Buyer.

53.2 The Seller must provide the Buyer with the RW Amount Information no later than 7 days after the Date of this Contract.

53.3 If the 'Buyer required to make a withholding payment?' option on the Schedule is selected 'no' or if no selection is made, the Seller warrants to the Buyer that the Buyer is not required to make a payment under section 14-250 in relation to the supply of the Property from the Seller to the Buyer.

53.4 The following clauses 53.5 to 53.9 inclusive only apply if the 'Buyer required to make a withholding payment?' option on the Schedule is selected 'yes'.

53.5 Subject to any adjustments to the Price that may arise after the date that the RW Amount Information is provided in accordance with clause 53.2 and which affect the RW Amount, the Seller warrants to the Buyer on the date that the RW Amount Information is provided to the Buyer that the Seller has provided the Buyer with the information required under section 14 255 of the Withholding Law in relation to the supply of the Property from the Seller to the Buyer, and that this information is true and correct to the Seller's knowledge.

53.6 The Buyer must provide the Seller with a copy of the 'GST property settlement withholding notification online form' confirmation email (or emails, if applicable) issued to the Buyer by the ATO no later than:

53.6.1 21 days after a written request from the Seller; or

53.6.2 7 days prior to the Date for Completion, whichever is the earlier.

53.7 The Buyer must provide the Seller with evidence of submission by the Buyer to the ATO of the 'GST property settlement date confirmation online form', with such evidence to be provided prior to or on Completion.

* Alter as necessary

- 53.8 The Seller irrevocably instructs the Buyer to draw as part of the Price, and the Buyer must draw and retain on Completion, an unendorsed bank cheque payable to the ATO for the RW Amount.
- 53.9 In relation to the unendorsed bank cheque required by clause 53.8, the Buyer must:
- 53.9.1 forward the unendorsed bank cheque to the ATO immediately after Completion; and
 - 53.9.2 provide the Seller with evidence of payment of the RW Amount to the ATO.

Block 1 Section 46 Fraser
34 Carrodus Street, Fraser